



# Aquarium Catalogue

## 2023-2024.



**For a successful aquarium.**

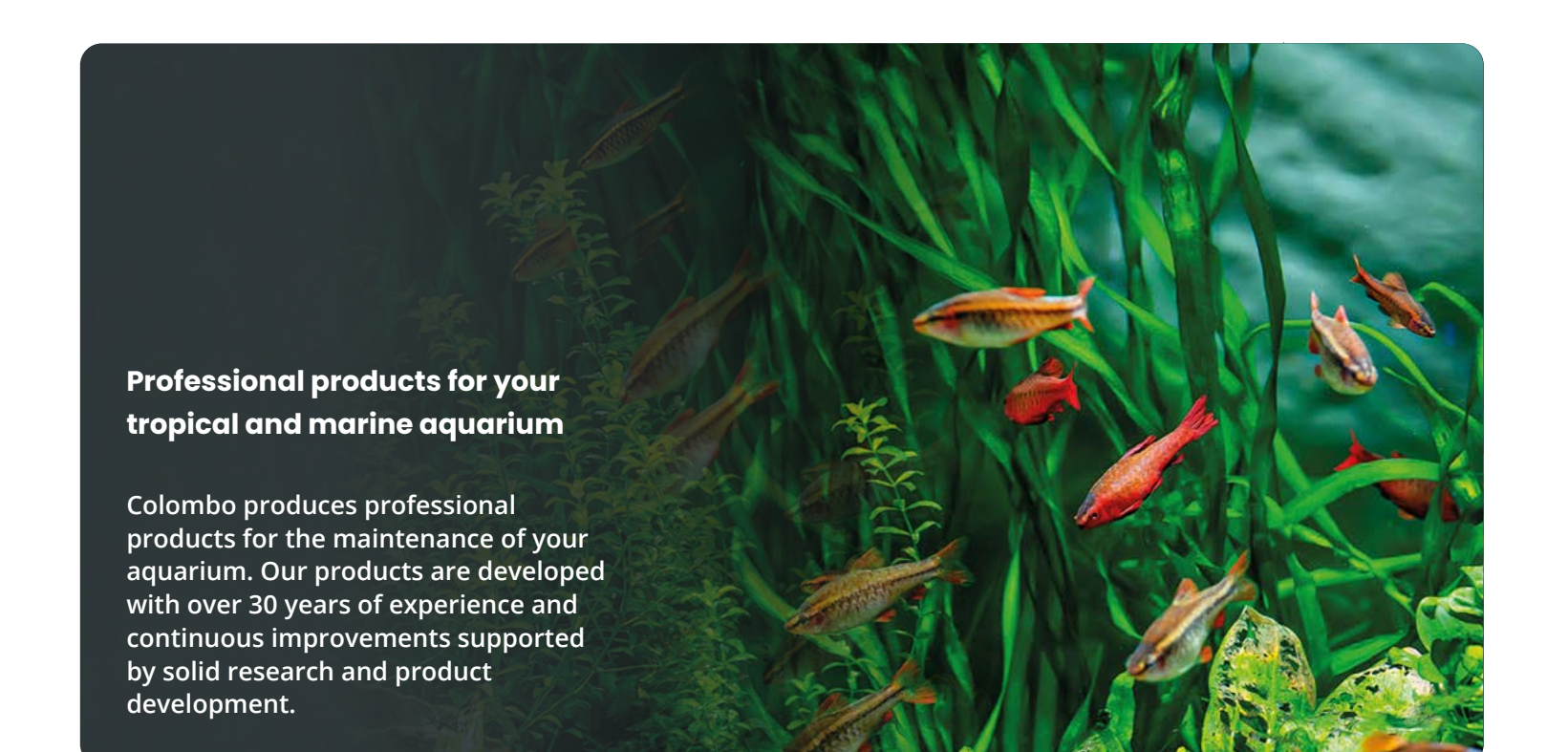

## Professional products for your tropical and marine aquarium

Colombo produces professional products for the maintenance of your aquarium. Our products are developed with over 30 years of experience and continuous improvements supported by solid research and product development.

### Index.

Go to:

**Freshwater testing and correction.**

Page 2 >

**Freshwater maintenance.**

Page 7 >

**Aquarium feed.**

Page 10 >

**Fish care.**

Page 12 >

**Fresh bacteria.**

Page 16 >

**Substrate.**

Page 18 >

**Fertilizer.**

Page 21 >

**CO<sub>2</sub> systems.**

Page 25 >

**Marine tests.**

Page 31 >

**Marine maintenance.**

Page 36 >

**Marine care.**

Page 40 >

**Fish care & Pest control.**

Page 45 >

All prices stated are recommended retail prices (incl. VAT). These prices may therefore differ from the retail prices in a shop or with an Internet supplier, you cannot derive any rights from them.

Despite all the care taken with the text, the publisher cannot accept liability for any damage that may arise from any errors that may appear in this catalogue. We are not responsible for any printing errors.

# Aquatest Testlab Professional.

With the Colombo Testlab, you have all the Aquatest drip tests in one handy case, which is also economical.

There are videos on our website showing how to perform the water test. This makes water testing very simple!

Visit [www.colombo.nl](http://www.colombo.nl) and try it yourself.



## Including.



Acidity



Carbonate Hardness



General Hardness



Ammonia



Nitrite



Nitrate



Phosphate

## Aquatest Testlab Professional.

Complete test kit to measure the 7 important freshwater aquarium water values. Contains professional drop tests for pH, GH, KH, NO2, NO3, NH3 & PO4. All supplies are in a handy plastic case.

The included test tubes and complete instructions for use make water testing very easy. In the case, you keep all tests together.

If one of the tests in the case runs out, you can use loose Colombo aqua tests as replacements.

With the Colombo Aqua testlab, you can test the 7 important water values 40 times, a total of 280 water tests!

### COLOMBO AQUA TESTLAB PRO.

S.R.P.

€52,49

Art. no.: A5010990



## Clean water is the base ingredient for a healthy aquarium.

Complete range of drip tests for freshwater aquariums. Tests available for pH - KH - GH - Ammonia - Nitrite - Nitrate - Phosphate. With the Quicktest strip you can test pH - KH - GH - Nitrite - Nitrate and Chlorine values. The tests are easy to use and provide a reliable measurement result. Whichever test you choose, regular testing of the water is essential to maintain your aquarium.



Professional drop test for precise determination of acidity in freshwater aquariums.

**Test range pH 6 - 9**

The handy visualised instructions, included test tubes and colour chart make testing easy.

Contents sufficient for 40x pH testing.

### pH test

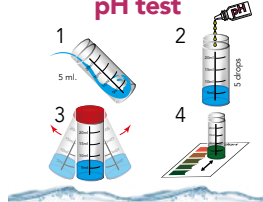

Ideal value/Idealwaarde/ Valeur idéale/Ideale waarde

- General pH 7.0 - 8.0
- Discus & Plants pH 6.0 - 7.0
- Tanganyika & Malawi cichlids pH 8.0 - 8.5

C3517100

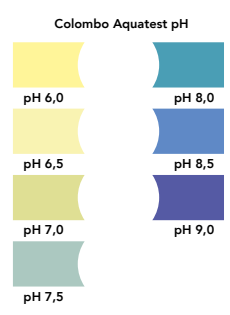

Colombo Aquatest pH

- pH 6,0
- pH 6,5
- pH 7,0
- pH 7,5
- pH 8,0
- pH 8,5
- pH 9,0

**COLOMBO AQUA PH TEST.**  
S.R.P. **€9,99**  
Art. no.: A5010960





Professional drop test for precise determination of carbonate hardness in freshwater aquariums.

**Precise test results due to clear colour change at different values.**

The handy visualised instructions and included test tubes make testing easy.

Contents sufficient for an average of 40x KH testing.

### KH test



Ideal value/Idealwaarde/ Valeur idéale/Ideale waarde

- General KH 6 - 8 °DH
- Discus & Plants KH 1 - 4 °DH
- Tanganyika & Malawi cichlids KH 8 - 10 °DH

C3517100



**COLOMBO AQUA KH TEST.**  
S.R.P. **€9,99**  
Art. no.: A5010963





Professional drop test for precise determination of total hardness in freshwater aquariums.

**Precise test results due to clear colour change at different values.**

The handy visualised instructions and included test tubes make testing easy.

Contents sufficient for an average of 40x GH testing.

### GH test



Ideal value/Idealwaarde/ Valeur idéale/Ideale waarde

- General GH 8 - 12 °DH
- Discus & Plants GH 4 - 8 °DH
- Tanganyika & Malawi cichlids GH 10 - 14 °DH

C3517103



**COLOMBO AQUA GH TEST.**  
S.R.P. **€9,99**  
Art. no.: A5010965





Professional drop test for precise determination of ammonia value in freshwater aquariums.

**Sensitive test also for measuring low values.**

The handy visualised instructions and included test tubes make testing easy.

Contents sufficient for 40x Ammonia level testing.

### NH<sub>3</sub> test Ammonia



Ideal value/Idealwaarde/ Valeur idéale/Ideale waarde

- Safe < 0,5 mg/l
- Alert 0,5 - 1 mg/l
- Warning > 1 mg/l

C3517103



**COLOMBO AQUA AMMONIA TEST.**  
S.R.P. **€15,29**  
Art. no.: A5010968







### NO<sub>2</sub> test Nitrite

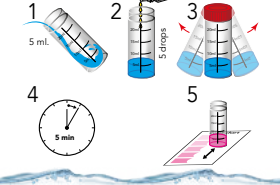

Ideal value/Idealwaarde/ Valeur ideale/ Ideale waarde

✔ Safe < 0,5 mg/l    
 ⚠ Alert 0,5 - 1 mg/l    
 ✘ High > 1 mg/l

C3517101

Professional drop test for precise determination of nitrite value in freshwater aquariums.

**Sensitive test also for measuring low values.**

**The handy visualised instructions and included test tubes make testing easy.**

**Contents sufficient for 40x Nitrite level testing.**

**COLOMBO AQUA NITRITE TEST.**  
S.R.P. **€9,99**  
Art. no.: A5010970





Ideal value/Idealwaarde/ Valeur ideale/ Ideale waarde

✔ < 0,5 mg/l    
 ⚠ 0,5 - 1 mg/l    
 ✘ > 1 mg/l

C3517101

Quicktest test strips for freshwater, contains 50 test strips with which you can quickly and conveniently measure the 6 most important values of aquarium water. Test the following values, acidity, carbonate hardness, total hardness, nitrite, nitrate and chlorine

**Easily test your water values in 1 minute.**

**Suitable for aquarium and pond.**

**You can test 50 x 6 values, a total of 300 test values! After opening the packaging, store in a dry place and have a limited shelf life.**

**COLOMBO AQUA QUICKTEST 6 - 50 STRIPS.**  
S.R.P. **€16,99**  
Art. no.: A5020290





### NO<sub>3</sub> test Nitrate

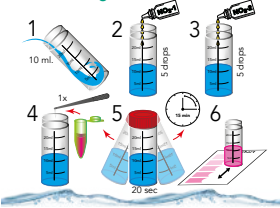

Ideal value/Idealwaarde/ Valeur ideale/ Ideale waarde

✔ Ideal < 50 mg/l    
 ⚠ High 50 - 100 mg/l    
 ✘ Too high > 100 mg/l

C3517102

Professional drop test for precise determination of nitrate value in freshwater aquariums.

**Test range from 0.0 - 100 mg/l**

**The handy visualised instructions and included test tubes make testing easy.**

**Contents sufficient for 40x Nitrate level tests.**

**COLOMBO AQUA NITRATE TEST.**  
S.R.P. **€15,29**  
Art. no.: A5010973



### PO<sub>4</sub> test Phosphate



Ideal value/Idealwaarde/ Valeur ideale/ Ideale waarde

✔ Ideal < 1 mg/l    
 ⚠ High 1 - 2,5 mg/l    
 ✘ Too high > 2,5 mg/l

C3517104

Professional drop test for precise determination of phosphate content in freshwater aquariums.

**Test range from 0.0 - 5 mg/l**

**The handy visualised instructions and included test tubes make testing easy.**

**Contents sufficient for 40x phosphate level testing.**

**COLOMBO AQUA PHOSPHATE TEST.**  
S.R.P. **€15,29**  
Art. no.: A5010975

# Correcting water values.



## pH min.

Reduces the pH (acidity)

Colombo pH Min lowers the acidity of the water. An incorrect pH level can be harmful to fish and plants, therefore test the pH level regularly and correct if necessary.



A stable pH value requires a correct KH of 6-10, therefore check the KH value first, and correct it if necessary with Colombo KH Plus before correcting the pH.

We recommend reducing pH by up to 1 unit per day.

Use: 1 ml pH-Min per 5 litres of aquarium water lowers the pH by about 1 unit depending on the KH. Repeat the next day if necessary.

### COLOMBO pH MIN 100 ML.

S.R.P. €6,59

Art. no.: A5010930



### COLOMBO pH MIN 250 ML.

S.R.P. €13,69

Art. no.: A5010932



## KH plus.

Increases KH (carbonate hardness)

Colombo KH Plus increases the carbonate hardness of the water, a correct KH between 6-10 DH is essential for safe and stable pH values. KH is a measure of the total amount of dissolved carbonates in the water. Test the water regularly and correct any values that are too low with Colombo KH Plus.



If the KH is too low, the pH can fluctuate rapidly, which is very harmful.

We recommend increasing the hardness by up to 2DH per day.

Use: 1 ml KH Plus per 5 litres of aquarium water increases the KH by 2 DH. Repeat the next day if necessary.

### COLOMBO KH PLUS 100 ML.

S.R.P. €6,59

Art. no.: A5010935



### COLOMBO KH PLUS 250 ML.

S.R.P. €13,69

Art. no.: A5010937



## GH plus.

Increases salts and minerals

Colombo GH Plus increases the amount of minerals and salts in the water, these salts are needed for healthy fish and plants. The ideal value of GH is 8-12DH. Test the water regularly and correct any values that are too low with Colombo GH Plus.



Too low a GH level is bad for fish health and the growth of your plants.

We recommend increasing the hardness by up to 2DH per day.

Use: 1ml GH Plus per 5 litres of aquarium water increases the GH by 2 DH. Repeat the next day if necessary.

### COLOMBO GH PLUS 100 ML.

S.R.P. €6,59

Art. no.: A5010940



### COLOMBO GH PLUS 250 ML.

S.R.P. €13,69

Art. no.: A5010943





## Ammo Stop.

**Immediately removes ammonia from your aquarium water**

Colombo Ammo Stop protects your fish by removing poisonous AMMONIA quicker than any other product on the market. The PADS unique round design allows unrestricted flow within the filter which is vital for the Bacteria Population and last up to 12 weeks. Ammo Stop can be used in conjunction with our Nitro and Posho pads and is suitable for both tropical and cold-water aquariums.



ø 12,5 cm

Immediately removes ammonia from your aquarium water. Most cost-effective products on the market lasting 12 weeks.

New aquaria can be stocked immediately without the fear of an ammonia spike or fish loss. Our advanced product will gradually absorb less ammonia, allowing the filter to mature naturally with biological bacteria without the fear of an Ammonia spike.

Pack contains 3 individually sealed 100 gram pads, sufficient for up to 1500 liters of water.

**COLOMBO AMMO STOP.**

S.R.P.

**€34,99**

Art. no.: A5020001



8 715897 341571

## Nitro Stop.

**Filter pads for removing nitrite and nitrate**

Colombo Nitro Stop removes NITRATE quickly and safely from aquarium water and work up to 10 weeks. Although nitrate is also an important food source for plants, too much nitrate stresses fish and can cause algae. Nitrate is removed through selective ion-exchange, our premium product works in a wide range of pH and temperature conditions. Nitro Stop can be used in conjunction with our Ammo and Posho pads and is suitable for both tropical and cold-water aquariums.



ø 12,5 cm

For clear, algae free water, great for heavily stocked aquariums.

Nitrate Remover helps reduce nuisance algae by starving it of its primary food source nitrate.

Pack contains 3 individually sealed 100 gram pads, sufficient for up to 350 liters of water, pads are effective for up to 10 weeks, load dependent. Pads can be regenerated.

**COLOMBO NITRO STOP.**

S.R.P.

**€34,99**

Art. no.: A5020003



8 715897 341588

## Phosho Stop.

**Filter pads for removing phosphate**

Colombo Phosho Stop is a premium-grade ion exchange resin that removes PHOSPHATE quickly and safely. Our premium product works in a wide range of pH and temperature conditions and can be used in conjunction with our Ammo and Posho pads. Suitable for both tropical and cold-water aquariums.



ø 12,5 cm

Removes the food source from nuisance algae, as a result you get extremely clear, algae free water.

The PADS unique round design allows unrestricted flow within the filter which is vital for the Bacteria Population and last up to 12 weeks. Phosphate is removed through selective ion-exchange.

Pack contains 3 individually sealed 100 gram pads, sufficient for up to 1500 litres of water, effective up to 12 weeks, load dependent.

**COLOMBO PHOSPHO STOP.**

S.R.P.

**€34,99**

Art. no.: A5020007



8 715897 341595



# Colombo Start.

Colombo has developed a 'starting system' to make starting the aquarium care free. Aqua Start makes tap water suitable for the aquarium and protects the fish while Bacto Start initiates and sustains your biological filtration. This way the aquarium comes to life quickly and makes keeping fish easy.



## The start up of a new aquarium will take approximately 4 weeks.

1. Fill the aquarium with water, add Aqua Start to the water and Bacto Start to the filter material.
2. After livestock has been added to the aquarium, a weekly water change of 20% needs to be made, add Aqua Start after every water change.
3. Check the ammonia and nitrite levels twice a week, make an additional water change if these values are too high.

## Pay attention to the values.

After approximately 14 days the ammonia levels will no longer rise, the ammonia test will indicate a value between 0 and 0,5 mg/l.

The nitrite level can still become too high, in order to keep the nitrite level low, for the first fortnight do a weekly water change of 20% and add Aqua Start.

## Aqua Start.

Makes tap water suitable for fish.

Colombo Aqua Start binds heavy metals, chlorine and other toxic substances, making tap water suitable for your fish. Because Colombo Aqua Start also contains coagulants, it also improves the clarity of your aquarium.



For making tap water suitable when filling, starting up and changing your aquarium.

Aqua start contains colloids and vitamins to strengthen your fish's mucous membrane, thereby reducing the risk of disease.

Contents: 100 ml, enough for 250 litres. Use: add 4 ml per 10 litres of water once when filling the aquarium, then at each water change add 4 ml per 10 litres to the fresh water only.

### COLOMBO AQUA START 100 ML.

S.R.P.

€6,59

Art. no.: A5010900



### COLOMBO AQUA START 250 ML.

S.R.P.

€13,69

Art. no.: A5010903



## Bacto Start.

Bacteria for aquarium filters.

Colombo Bactostart contains live filter and cleaning bacteria for a quick start of your aquarium. These bacteria are essential for the biological balance in the aquarium and keep the water clean and healthy. The start-up of an aquarium takes around 6-8 weeks, with Colombo Bacto Start you will shorten this period and ensure optimal filter performance.



For a quick start-up of the aquarium filter in new aquariums, so you can place fish in the aquarium quicker. Administering bacteria is also important after a major cleaning or drug treatment.

Colombo Bacto Start works best in combination with Colombo Aqua Start. Aqua Start makes the water suitable for the fish. Bacto Start provides the live bacteria.

Contents: 100 ml sufficient for 100 litres of water. Application: in new aquaria, add 10 ml of Bacto Start per 10 litres of water. In existing aquaria and after water changes, add 5 ml per 10 litres every week. Overdosage is not harmful and ensures faster results!

### COLOMBO BACTO START 100 ML.

S.R.P.

€6,59

Art. no.: A5010905



### COLOMBO BACTO START 250 ML.

S.R.P.

€13,69

Art. no.: A5010907





# Maintenance.

New.



## Black Water.

**Creates Natural Black Water and stabilizes pH.**

Colombo Black Water contains peat extracts, creating natural tropical water (so-called black water) like your fish are used to in their natural habitat. The bioactive substances and natural tannins and humic acids promote vitality, natural colouring and disease resistance of the fish. As a result, your fish will feel at home and display their natural behaviour.

Suitable for all freshwater fish such as discus and angelfish, catfish, Tetras or South American cichlids, and shrimps and crustaceans.

Colombo Black Water stabilises pH levels naturally and improves water quality. The natural peat extract colours the water slightly brownish, reducing light and algae growth.

Contents: 250 ml sufficient for 1000 litres of water. Use: At the start, pump 1x (2.5ML) per 10 litres of aquarium water, then repeat dosing every 2 weeks, adding 2.5 ML per 10 litres of fresh water with every water change.

**COLOMBO BLACK WATER 250 ML.**

S.R.P.

**€12,99**

Art. no.: A5010919

3



8 715897 342585

## Goldfish Care.

**For healthy Goldfish.**

Use Colombo Goldfish care for healthy goldfish. Goldfish Care is a 100% natural salt enriched with vitamins, minerals and care ingredients, the ideal salt content for goldfish is 0.1%. The salts and additives in Goldfish Care maintain a healthy environment and prevent fish diseases.



For optimal results, follow the Colombo maintenance system and replace Bacto Care with Goldfish Care.

Colombo goldfish care is best dissolved in warm water and then distributed over the aquarium.

Contents 100 ml. Enough for over 100 litres. Use: When filling the aquarium, add 1 gram Goldfish care per litre of aquarium water once, then at each water change add 1 gram per litre of water to the fresh water only.

**COLOMBO GOLDFISH CARE 100 ML.**

S.R.P.

**€6,59**

Art. no.: A5010920



8 715897 225475

## Algisin.

**Effective control of algae!**

Algisin is effective against all types of algae in freshwater aquaria. By reducing nutrient uptake, among other things, algae can no longer grow and eventually die. Aquarium plants can absorb their nutrients through the aquarium bed and are thus spared.



Colombo Algisin fights algae and ensures a crystal-clear aquarium!

Algisin is effective against all types of algae and contains no copper.

Dosage: 1 ml per 20 litres of water, with 100 ml 1000 litres can be treated twice. Always test the aquarium water first and correct if necessary before adding algicide!

**COLOMBO ALGISIN AQUARIUM 100 ML.**

S.R.P.

**€9,49**

Art. no.: A5010945



8 715897 225550

**COLOMBO ALGISIN AQUARIUM 250 ML.**

S.R.P.

**€17,99**

Art. no.: A5010947



8 715897 225567

# Colombo maintenance system.



## Aqua Care.

**Naturally clean & clear water.**

Colombo Aqua Care naturally keeps your aquarium clean and clear. The breakdown of nutrients such as nitrate and phosphate is stimulated in a biological way, thus improving and stabilising water quality. Colombo maintenance products are easy to use and environmentally friendly.



Maintenance product for a healthy aquarium, change 20% of the aquarium water every 2 weeks and add Aqua Care.

Use Aqua Care in combination with Colombo Bacto Care for optimal results. Test aquarium water monthly and correct if necessary.

Contents: 100 ml sufficient for 500 litres. Dosage: 1 ml per 5 litres of water every 2 weeks. After administration, the aquarium water will be cloudy for about 24 hours.

### COLOMBO AQUA CARE 100 ML.

S.R.P.  
**€6,59**

Art. no.: A5010910



### COLOMBO AQUA CARE 250 ML.

S.R.P.  
**€13,69**

Art. no.: A5010912



## Bacto Care.

**Maintains biology.**

Colombo Bacto Care, live filter and cleaning bacteria that improve filter performance and biological balance in the aquarium. For a clean and healthy aquarium. Colombo maintenance products are easy to use and environmentally friendly.



Maintenance product for a healthy aquarium, change 20% of the aquarium water every 2 weeks and add Bacto Care.

Use Bacto Care in combination with Colombo Aqua Care for optimal results. Test aquarium water monthly and correct if necessary.

Contents 100 ml sufficient for 500 litres. Dosage: 2 ml per 10 litres of water every 2 weeks.

### COLOMBO BACTO CARE 100 ML.

S.R.P.  
**€8,39**

Art. no.: A5010915

4



### COLOMBO BACTO CARE 250 ML.

S.R.P.  
**€14,69**

Art. no.: A5010917



## Aqua Salt.

**For healthy fish with radiant colours.**

Aqua Salt is an all-natural purified sea salt rich in minerals. Aqua Salt ensures a healthy environment in the water, thus preventing fish diseases. The use of Aqua Salt is especially important for live-bearing fish, goldfish and brackish water fish, but be careful with fish from South America as they thrive in very soft water.

Many fish thrive better in water low in salts; the ideal salinity level for assimilation of these fish is 0.1%.

Colombo Aqua Salt is best dissolved in warm water and then distributed over the aquarium.

Use: When filling the aquarium, add 1 g of Aqua Salt once per 1 litre of aquarium water, then at each water change add 1 g per 1 litre of water to the fresh water only.

### COLOMBO AQUA SALT 250 ML.

S.R.P.  
**€8,39**

Art. no.: A5010850



### COLOMBO AQUA SALT 1000 ML.

S.R.P.  
**€19,49**

Art. no.: A5010855



Good water quality is essential for a healthy aquarium. With the Colombo maintenance system the maintenance of your aquarium is made easy and simple. Make a 20% water change every fortnight and add Colombo Bacto Care according to the instructions on the packaging.

For feeding tropical fish a flake food and a pellet food available.

Both foods contain a well balanced composition based on the feeding needs of tropical fish. Both the flake food and the pellet food are well accepted and pollution of the water is minimised.

Colombo advises the use of Tropical pellets for daily nutrition of your tropical fish. Pellets contain more nutrients and pollute the water less compared to flake food.

### Tropical Pellet composition:

mycoproteins, cereals, fish and fish derivatives, yeasts, oils and fats, derivatives of vegetable origin, minerals, algae (0.8% spirulina), fruits.



### Tropical Flake composition:

Cereals, fish and fish derivatives, yeasts, mycoproteins, derivatives of vegetable origin, oils and fats, insects, molluscs and crustaceans (2.2% shrimp), algae (0.6% spirulina), minerals.



## Tropical Pellet.

Colombo Tropical Pellet encourages beautiful colours and aids growth. The small pellet is suitable for almost all types of fish. Tropical pellet has a high acceptance rate and is eagerly eaten by fish.



Daily food for tropical fish, the small pellet ensures healthy growth and beautiful colours.

Tropical pellets have much more nutritional value and pollute the water much less than flake food.

### COLOMBO TROPICAL PELLETT 100ML/70GR.

S.R.P.

**€4,19**

Art. no.: A3020545



8 715897 225321

### COLOMBO TROPICAL PELLETT 250ML/160GR.

S.R.P.

**€9,49**

Art. no.: A3020550



8 715897 225338

### COLOMBO TROPICAL PELLETT 1.000ML/630GR.

S.R.P.

**€26,99**

Art. no.: A3020555



8 715897 225345

## Tropical Flake.

Colombo Tropical flakes is a balanced food containing everything your tropical fish need on a daily basis. This food has a high acceptance rate and is eagerly eaten by fish.



Daily food for tropical fish, the small flake ensures healthy growth and beautiful colours.

Contains spirulina, artemia, proteins, minerals, healthy fatty acids and antioxidants for healthy fish.

### COLOMBO TROPICAL FLAKE 100 ML.

S.R.P.

**€4,19**

Art. no.: A3020515



8 715897 225260

### COLOMBO TROPICAL FLAKE 250 ML.

S.R.P.

**€7,99**

Art. no.: A3020520



8 715897 225277

### COLOMBO TROPICAL FLAKE 1000 ML.

S.R.P.

**€19,99**

Art. no.: A3020525



8 715897 225284

For goldfish in aquariums a flake food and a pellet food are available.

Both foods are adjusted to the feeding requirements of goldfish, which are very different compared to tropical fish.

Colombo advises to feed Goldfish pellets for the daily nutrition of goldfish.

### Goldfish Pellet composition:

Cereals, yeasts, insects, fish and fish derivatives, derivatives of vegetable origin, mycoproteins, vegetables, molluscs and crustaceans (5% shrimp), oils and fats, algae.



### Goldfish Flake composition:

Cereals, mycoproteins, fish and fish derivatives, yeasts, oils and fats, derivatives of vegetable origin, molluscs and crustaceans (1.8% shrimp), sugars.



 Pellet = sinking



## Tropical Pellet.

Colombo Goldfish, sinking pellet food specially tailored to the specific nutritional needs of goldfish that differ substantially from tropical fish. Contains spirulina, proteins, minerals, healthy fatty acids and antioxidants. This pellet food has a high acceptance rate and is eagerly eaten by fish.



Daily food for goldfish, the zinc-coated pellet ensures healthy growth and beautiful colours.

Goldfish pellets have much more nutritional value and pollute the water much less than flake food.

### COLOMBO GOLDFISH PELLETT 100ML/70GR.

S.R.P.

**€4,19**

Art. no.: A3020530



### COLOMBO GOLDFISH PELLETT 250ML/160GR.

S.R.P.

**€7,99**

Art. no.: A3020535



### COLOMBO GOLDFISH PELLETT 1.000ML/630GR.

S.R.P.

**€19,49**

Art. no.: A3020540



## Tropical Flake.

Colombo Goldfish flake food, specially tailored to the specific nutritional needs of goldfish that differ substantially from tropical fish. Contains spirulina, proteins, minerals, healthy fatty acids and antioxidants. This flake food has a high acceptance rate and is eagerly eaten by fish.



Daily food for goldfish, the small flake ensures healthy growth and beautiful colours.

Contains spirulina, artemia, proteins, minerals, healthy fatty acids and antioxidants for healthy fish.

### COLOMBO GOLDFISH FLAKE 100 ML.

S.R.P.

**€3,99**

Art. no.: A3020500



### COLOMBO GOLDFISH FLAKE 250 ML.

S.R.P.

**€7,39**

Art. no.: A3020505



### COLOMBO GOLDFISH FLAKE 1.000 ML.

S.R.P.

**€18,49**

Art. no.: A3020510



# Catappa.

Used for decades in Asia by every fish farmers as the natural method of preventing and curing disease.



## The advantages:

The leaves slowly release natural tannins and humic acids, which soften the water and increase the vitality of the fish. It stimulates the mucus layer and suppresses the level of bacteria and mould in the water.

Catappa leaves are an absolute must for South Asian fish species such as Betta and shrimp. Shrimps and bottom dwellers such as plecos see Catappa leaves as a delicacy and are therefore ideally suited as a natural supplementary food.



## Catappa Nano.

Suitable for Nano Aquariums.

Catappa leaves lower the ph, enhance the colours of fish and shrimp, are stress-reducing, and act as a preventative against diseases in the aquarium. These leaves give the aquarium a natural look and are supplementary food for shrimps and crayfish.



The leaves float for about 2 days, after which they sink.

Use: 1 leaf/15 - 30 l of water. The active ingredients are completely released after 1- 3 weeks.

Nano-Catappa, 10 leaves of 8-10 cm for small freshwater aquariums.

**COLOMBO CATAPPA NANO 10X.**

S.R.P.

**€5,99**

Art. no.: A5010835



8 715897 336195

## Catappa XL.

With antibacterial action.

Catappa leaves lower the ph, enhance the colours of fish and shrimp, are stress-reducing, and act as a preventative against diseases in the aquarium. These leaves give the aquarium a natural look and are supplementary food for shrimps and crayfish.



The leaves float for about 2 days, after which they sink.

Use: 1 leaf/50-100l water. The active ingredients are fully released after 3 weeks.

Catappa, 10 leaves from 12 to 20 cm for freshwater aquariums.

**COLOMBO CATAPPA 10X.**

S.R.P.

**€7,99**

Art. no.: A5010840



8 715897 336201

# Medication.

Fish can get sick due to different kinds of circumstances. Often diseases are caused by poor water quality or the new introduction of fish.

Also it's very important to recognise the symptoms of fish diseases at an early stage. Always test the water when fish diseases are a problem.

**In case of fish diseases, always test the water quality first with our Aquatest products.**



# Fish diseases – Cerpor for medication.



Sales of medication is subject to local legislation. Inform at the authorities if sales are allowed.



## Dactycid.

Against internal and external worms.

Colombo Dactycid is effective against internal and external worms, such as Nematodes, skin worms (Gyrodactylus) and gill worms (Dactylogyrus). Most worms are only visible under the microscope, although some intestinal worms can be seen hanging out of the anus.

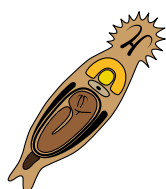

Flukes  
Gyrodactylus.

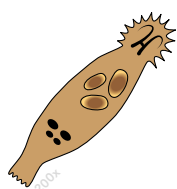

Dactylogyrus.

Effective action against skin flukes

Based on 40 years of experience and research, Colombo offers the most effective remedies for treating fish diseases.

Dosage: 2 ml per 10 litres of water, 100 ml is sufficient for 500 litres.

**CERPOR DACTYCID 100 ML – 500 L.**

S.R.P.

**€16,79**

Art. No.: A5010755  
3



**CERPOR DACTYCID 1000 ML – 5000 L.**

S.R.P.

**€78,99**

Art. No.: A5010766  
1



## Flagellex.

Against discus disease or flagellates.

Colombo Flagellex is effective against flagellates, also known as Discus or hole disease. Symptoms include transparent faeces stuck to the anus, reduced appetite to, in advanced stages, holes in the head and even the body.



Clear excrements.

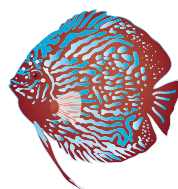

Holes caused by  
flagellates.

Effective action against flagellates, also known as discus disease

Based on 40 years of experience and research, Colombo offers the most effective remedies for treating fish diseases.

Dosage: 2 ml per 10 litres of water, 100 ml is sufficient for 500 litres.

**CERPOR FLAGELLEX 100 ML – 500 L.**

S.R.P.

**€24,79**

Art. No.: A5010785  
3



**CERPOR FLAGELLEX 1000 ML – 5000 L.**

S.R.P.

**€115,49**

Art. No.: A5010796  
1



## Alparex.

Against invisible parasites.

Colombo Alparex is effective against invisible parasites that cause a greyish veil on fish, such as Ichthyobodo, Chilodinella and Trichodina. In addition, white spot and fungus are effectively treated.

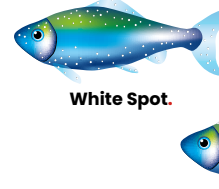

White Spot.



Fungus.

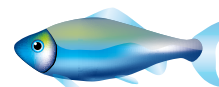

Invisible parasites.

Effective action against a wide variety of invisible parasites, white spot and fungi.

Based on 40 years of experience and research, Colombo offers the most effective remedies for treating fish diseases.

Dosage: 2 ml per 10 litres of water, 100 ml is sufficient for 500 litres.

**CERPOR ALPAREX 100 ML – 500 L.**

S.R.P.

**€16,79**

Art. No.: A5010742  
3



**CERPOR ALPAREX 1000 ML / 5000 L.**

S.R.P.

**€83,99**

Art. No.: A5010744  
1



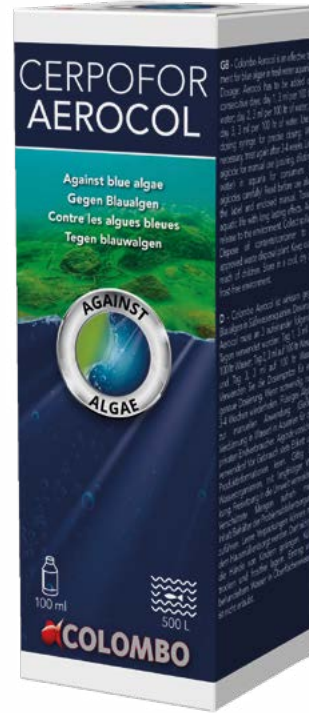

## Femsee.

Against fungus and white spot.

Colombo Femsee is effective against fungus and white spot. White Spot can be recognised by small white dots on head and body. Fungus looks like white to green wimpy tufts.



White Spot.

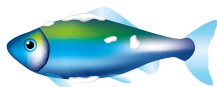

Fungus.

Effective action against white spot and fungi.

Based on 40 years of experience and research, Colombo offers the most effective remedies for treating fish diseases.

Dosage: 2 ml per 10 litres of water, 100 ml is sufficient for 500 litres.

### CERPOFOR FEMSEE 100 ML-500 L.

S.R.P.

€14,79

Art. No.: A5010770

3



8 715897 026768

### CERPOFOR FEMSEE 1000 ML-5.000 L.

S.R.P.

€66,99

Art. No.: A5010781

1



8 715897 043734

## Bactyfec.

Against bacterial infections.

Colombo Bactyfec is effective against bacterial infections such as fin rot, hole disease (skin ulcers), beak fungus and other signs of disease caused by bacterial infections.

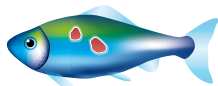

Hole disease.



Fin rot.

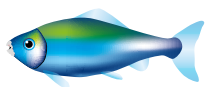

Mouthrush.

Effective action against bacterial problems

Based on 40 years of experience and research, Colombo offers the most effective remedies for treating fish diseases.

Dosage: 2 ml per 10 litres of water, 100 ml is sufficient for 500 litres.

### CERPOFOR BACTYFEC 100 ML-500 L.

S.R.P.

€16,79

Art. No.: A5010740

3



8 715897 026769

### CERPOFOR BACTYFEC 1000 ML-5000 L.

S.R.P.

€78,99

Art. No.: A5010751

1



8 715897 043710

## Aerocol.

Against blue algae.

Colombo Aerocol is effective against all types of blue-green algae in freshwater aquariums.



Effective action against all types of blue algae.

Harmful to snails and other invertebrates.

Dosage: Aerocol should be used on three consecutive days. Day 1 - 3 ml per 100 litres of water, Day 2 - 3 ml per 100 litres of water, Day 3 - 3 ml per 100 litres of water, Use a dosing syringe for precise dosing.

### CERPOFOR AEROCOL 100 ML-1000 L.

S.R.P.

€14,29

Art. No.: A5010820

3



8 715897 313486





# Fresh Bacto & PSB.

The live nitrifying bacteria in Colombo Fresh Bacto will get your aquarium up and running immediately and prevent the build-up of toxic ammonia and nitrite. PSB Bacteria have a great ability to break down organic pollution and create excellent water quality. Colombo Nannochloropsis algae are specifically selected for optimum nutritional value and quality.

**Fresh Bacto.**  
Add fish directly in a new aquarium.

Fish in the new aquarium right away? Normally you have to wait at least a week before you can put some fish in the aquarium, with Colombo Fresh Bacto your aquarium starts up very quickly, the live nitrifying bacteria go to work immediately and prevent problems with ammonia and nitrite.



**QUICK START** **FISH SAFE** **NO<sub>2</sub> NH<sub>3</sub>**

Store in the fridge <6°C, shake well, suitable for freshwater and seawater.

Use Colombo Fresh Bacto also after a major cleaning of the aquarium or filter or after treatment with medication, this will prevent water problems.

1000 ml is suitable for 1000 litres of aquarium water, overdosing does no harm, more bacteria means faster action.

**COLOMBO FRESH BACTO 1000 ML.**  
S.R.P. **€44,99**  
Art. No.: N3030113



8 715897 341564

**Fresh Bacto.**  
Add fish directly in a new aquarium.

Fish in the new aquarium right away? Normally you have to wait at least a week before you can put some fish in the aquarium, with Colombo Fresh Bacto your aquarium starts up very quickly, the live nitrifying bacteria go to work immediately and prevent problems with ammonia and nitrite.



**QUICK START** **FISH SAFE** **NO<sub>2</sub> NH<sub>3</sub>**

Store in the fridge <6°C, shake well, suitable for freshwater and seawater.

Use Colombo Fresh Bacto also after a major cleaning of the aquarium or filter or after treatment with medication, this will prevent water problems.

250 ml is suitable for 250 litres of aquarium water, overdosing does no harm, more bacteria means faster action.

**COLOMBO FRESH BACTO 250 ML.**  
S.R.P. **€14,99**  
Art. No.: N3030110



8 715897 336218



**Fresh PSB.**  
Perfect water quality and less pollution.

PSB bacteria provide great water quality and more beautiful fish. These live PSB bacteria go straight to work in the aquarium and break down organic pollution. The strong smell of PSB is normal, this means the bacteria are alive!



**QUICK ACTION** **CLEAR WATER** **REDUCES POLLUTION**

Store in the fridge <6°C, shake well, suitable for freshwater and seawater.

PSB bacteria also contain many vitamins, minerals and amino acids that promote aquarium and fish health.

250 ml is suitable for 250 litres of aquarium water, overdosing does no harm, more bacteria means faster action.

**COLOMBO FRESH PSB 250 ML.**  
S.R.P. **€9,99**  
Art. No.: N3030115



8 715897 336225

**Live Phytoplankton.**  
Healthy and natural nutrition for coral.

PSB bacteria provide great water quality and more beautiful fish. These live PSB bacteria go straight to work in the aquarium and break down organic pollution. The strong smell of PSB is normal, this means the bacteria are alive!



**100% NATURAL** **HEALTHY CORALS** **UPTO 2 MICRON**

Store in the fridge <6°C, shake well, suitable for freshwater and seawater.

Phytoplankton absorb nitrate and phosphate, reducing these values and thus helping to prevent algae growth.

Dosage: Start with 1 ml per 50 litres daily for 2 weeks; then increase to 1 ml per 25 litres of aquarium water.

**COLOMBO FRESH PLANKTON 250 ML.**  
S.R.P. **€7,99**  
Art. No.: N3030100



8 715897 264795



# Substrate, Fertilizer and CO<sub>2</sub> systems.

---

◀◀  
INDEX



## For beautiful aquarium plants

---

# The right substrate for healthy & optimal growth.

A good nutrient base is the basis for an attractively planted aquarium. Aquarium plants take nutrition from the ground in order to grow, and the roots can attach themselves in the ground.

For plant species such as Echinodorus and Cryptocoryne, a nutrient base is the most important food source for growth.

## What do plants need?

For optimal plant growth, 3 factors must be in balance: light, nutrition and CO<sub>2</sub>. The factor which is least available in the trinity will restrict plant growth and thus create scope for algae growth.

The light requirements of plants can be easily met by using aquarium lighting with special lamps that promote plant growth. The Colombo plants range includes a line of products that can provide the other factors that are important for healthy plant growth, namely nutrition and CO<sub>2</sub>.

Like plants in the garden, aquarium plants also require fertilisation. In addition to the nutrients which are absorbed through the roots, aquarium plants also take up nutrients through their leaves. CO<sub>2</sub> is indispensable for healthy plant growth. Generally speaking, aquarium water does not contain sufficient CO<sub>2</sub> to enable plants to grow properly. Colombo FloraBase Pro nutrient medium lowers the pH value of the water, thereby increasing the amount of CO<sub>2</sub> available.

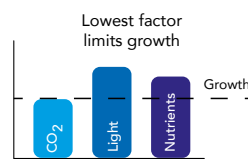
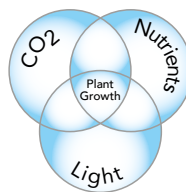

## Our soils.

When it comes to choosing the soil for your aquarium, Colombo has three products: NutriBase, ManoBase and FloraBase Pro.

The right soil is the base for healthy plants and optimal plant growth!

## NutriBase.

Substrate for Aquarium Plants

NutriBase is a complete nutrient base.



## ManoBase.

Natural substrate for plants & fish

ManoBase is a natural substrate that can be used as a top layer



## FloraBase Pro.

For fantastic plant growth

FloraBase Pro is a pH regulating soil for optimal plant growth.



# NutriBase.

Complete substrate for aquarium plants containing all necessary nutrients for healthy plant growth.

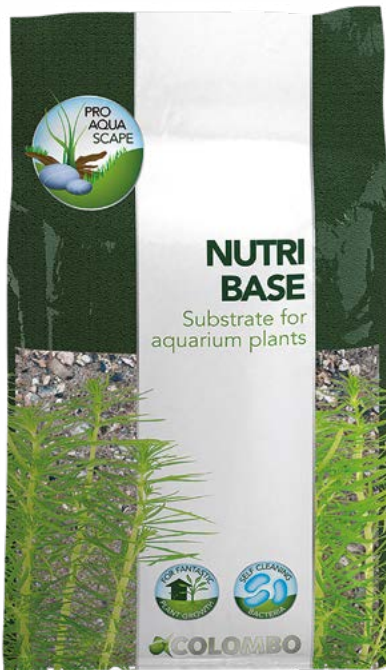

## NutriBase. Substrate for Aquarium Plants

Developed in collaboration with experts in growing plants, NutriBase contains all the necessary nutrients for healthy plant growth. NutriBase is the basic nutrient in the aquarium and should be covered with a top layer such as Mano Base or Flora Base Pro.



Complete substrate for aquarium plants, the open structure ensures good circulation in the aquarium bed

Added beneficial bacteria break down dirt and keep the substrate clean

Contents 5 litres, sufficient for a 5 cm layer in a 40x25 cm aquarium.

### COLOMBO FLORA NUTRI BASE 5 L.

S.R.P.

€18,99

Art. no.: A5010030



8 715897 164088

# ManoBase.

Colombo ManoBase is a natural soil with an open structure that enables optimal plant growth.

## 2 Colours.

ManoBase is only suitable for freshwater aquaria. ManoBase is available in two colours: red and black and in 5 or 10 litre bags. The diameter of the particles is 1-2 mm.



## ManoBase Red.

Better substrate than gravel

Colombo ManoBase is a natural substrate that can be used as a top layer in any aquarium, from beginner to specialist. Unlike solid gravel, ManoBase is open and light, both in terms of particles and structure. The open particles allow rapid and massive colonisation by beneficial bacteria, which are vital for water quality stability.



ManoBase is suitable for freshwater aquaria only.

ManoBase is available in two colours: red and black and in 5- or 10-litre bags. The diameter of the particles is 1-2 mm.

### COLOMBO FLORA MANO BASE RED 5 L.

S.R.P.

€14,99

Art. no.: A5010017



8 715897 337628

### COLOMBO FLORA MANO BASE RED 10 L.

S.R.P.

€20,99

Art. no.: A5010020



8 715897 336959

## ManoBase Black.

Contrasting colour enhances the colour of the fish

Colombo ManoBase is a natural substrate that can be used as a top layer in any aquarium, from beginner to specialist. Unlike solid gravel, ManoBase is open and light, both in terms of particles and structure. The open particles allow rapid and massive colonisation by beneficial bacteria, which are vital for water quality stability.



ManoBase is suitable for freshwater aquaria only.

ManoBase is available in two colours: red and black and in 5- or 10-litre bags. The diameter of the particles is 1-2 mm.

### COLOMBO FLORA MANO BASE BLACK 5 L.

S.R.P.

€17,99

Art. no.: A5010023



8 715897 337655

### COLOMBO FLORA MANO BASE BLACK 10 L.

S.R.P.

€24,49

Art. no.: A5010025



8 715897 336966



# FloraBase Pro.

pH regulating soil for fantastic plant growth.



## FloraBase Pro.

pH regulating soil for fantastic plant growth.



Made in Japan

FloraBase Pro is a unique aquarium soil produced in Japan. FloraBase lowers and stabilises the pH to 6. At this pH level, more CO<sub>2</sub> is naturally available for good plant growth. The CO<sub>2</sub> content of the water is very important for optimal plant growth. Many fish species such as Discus fish, species from South America and shrimps like a low pH of 6, these animals love FloraBase Pro! FloraBase Pro is recommended by experts!

### Attention!

FloraBase PRO should not be washed before use, any cloudiness of the water is harmless and disappears after a few days.

Starting an aquarium is much easier with FloraBase Pro, the plants grow better due to the low pH and at a pH level below 7, you will not be bothered by toxic ammonia.

FloraBase Pro is rich in nutrients and its open structure ensures strong roots. The pellets do not disintegrate and retain their shape.

## Plant growth in 30 days with FloraBase soil.



Day 1



Day 30



### COLOMBO FLORA BASE PRO FINE 1 L.

S.R.P.

€9,99

Art. no.: A5010080

6



8 715897 257438

### COLOMBO FLORA BASE PRO FINE 2,5 L.

S.R.P.

€19,99

Art. no.: A5010050



8 715897 158322

### COLOMBO FLORA BASE PRO FINE 5 L.

S.R.P.

€35,99

Art. no.: A5010055



8 715897 158339

### COLOMBO FLORA BASE PRO FINE 10 L.

S.R.P.

€62,99

Art. no.: A5010060



8 715897 158340

### COLOMBO FLORA BASE PRO COARSE 2,5 L.

S.R.P.

€17,99

Art. no.: A5010065



8 715897 158353

### COLOMBO FLORA BASE PRO COARSE 5 L.

S.R.P.

€32,49

Art. no.: A5010070



8 715897 158360

### COLOMBO FLORA BASE PRO COARSE 10 L.

S.R.P.

€58,49

Art. no.: A5010075



8 715897 243035

# FloraGrow.



## FloraGrow. Liquid leaf fertilizer

FloraGrow is a liquid plant food for normally planted aquariums. It supplies the water with the nutrients that plants absorb from the water through their leaves. It contains all necessary nutrients and a special iron additive that can be absorbed directly by the plant. Dose FloraGrow once a week.

Developed by plant experts, convenient dosing with hand pump.

Plant food for normally planted aquariums, with special iron addition.

Contents: 250 ml is sufficient for 1250 litres of water. Dosage: pump once for 5 litres of aquarium water, dose weekly.

Weekly plant food with special iron addition, for normally planted aquariums

Contents: 500 ml is sufficient for 2,500 litres of water. Dosage: pump once for 5 litres of aquarium water, dose weekly.

Contents: 2,500 ml is sufficient for 12,500 litres of water. Dosage: 10 ml per 50 litres of aquarium water, weekly dosage.

### COLOMBO FLORA GROW 250 ML.

S.R.P.  
**€8,39**

Art. no.: A5010100



8 715897 244063

### COLOMBO FLORA GROW 500 ML.

S.R.P.  
**€13,79**

Art. no.: A5010105



8 715897 244070

### COLOMBO FLORA GROW XL 2,5 L.

S.R.P.  
**€28,99**

Art. no.: A5010110



8 715897 244087



## FloraGrow Carbo. Alternative for CO<sub>2</sub>

FloraGrow Carbo contains a substance that serves as a replacement for CO<sub>2</sub>. In aquaria without a CO<sub>2</sub> system, the use of FloraGrow Carbo is indispensable. By adding FloraGrow Carbo, plants can absorb the alternative carbon source without having to administer CO<sub>2</sub>.

Besides its positive effect on plant growth, Carbo also helps reduce algae growth!

Liquid alternative to CO<sub>2</sub>, must be added daily for optimal results.

Contents: 250 ml is sufficient for 12500 litres of water. Dosage: pump once for 50 litres of aquarium water, dose daily.

Contents: 500 ml is sufficient for 25000 litres of water. Dosage: pump once for 50 litres of aquarium water, dose daily.

Contents: 2500 ml is sufficient for 125,000 litres of water. Dosage: 1ml for 50 litres of aquarium water, dose daily.

### COLOMBO FLORA CARBO 250 ML.

S.R.P.  
**€8,39**

Art. no.: A5010130



8 715897 244124

### COLOMBO FLORA CARBO 500 ML.

S.R.P.  
**€13,79**

Art. no.: A5010135



8 715897 244131

### COLOMBO FLORA CARBO XL 2,5 L.

S.R.P.  
**€31,49**

Art. no.: A5010140



8 715897 244148



## FloraGrow Pro. Special leaf fertilizer

FloraGrow Pro is special liquid plant food for heavily planted aquaria, Flora Grow Pro was developed together with aquarium plant nursery Aquafleur and contains all important nutrients in a balanced composition plus nitrates and phosphates for brilliant plant growth.

In normally planted aquaria, sufficient nutrients are present because they are released from fish food and transformed in the filter. In aquaria with many plants, these substances are insufficient, in this case use FloraGrow Pro.

Liquid foliar feed for heavily planted "scapers" aquariums with relatively few fish

Contents: 250 ml is sufficient for 1250 litres of water. Dosage: pump once for 5 litres of aquarium water, dose weekly.

Contents: 500 ml is sufficient for 2,500 litres of water. Dosage: pump once for 5 litres of aquarium water, dose weekly.

Contents: 2500 ml is sufficient for 12500 litres of water. Dosage: pump once for 5 litres of aquarium water, dose weekly.

### COLOMBO FLORA GROW PRO 250 ML.

S.R.P.  
**€11,49**

Art. no.: A5010115



8 715897 244094

### COLOMBO FLORA GROW PRO 500 ML.

S.R.P.  
**€18,49**

Art. no.: A5010120



8 715897 244100

### COLOMBO FLORA GROW PRO XL 2,5 L.

S.R.P.  
**€39,99**

Art. no.: A5010125



8 715897 244117



# Supplements.



## Nutri Caps.

Nutri Caps allow you to introduce nutrition into the aquarium bed, directly at the roots where the plants need it. Plants take up nutrition via the leaves, but also via the soil, which is why sufficient nutrition in the soil is important, especially for plants with many roots such as Echinodorus etc.! Even if you start with a good nutrient medium, after a while the medium becomes poor in nutrients, Nutricaps offer the solution.

Fertiliser capsules for the aquarium base, provides nutrition directly to the roots of the plants.

The Nutri Caps work with Osmocote which ensures a long-term regular release of nutrients for optimal plant growth.

Package contains 10 capsules. Once every 6 months, insert 1 capsule deep into the soil on large plants or use 1 capsule per 20 cm<sup>2</sup> of soil surface.

**COLOMBO FLORA NUTRI CAPS 10X.**

S.R.P.

**€8,99**

Art. no.: A5010145



8 715897 244155

## FE-Tabs (Iron Tablets).

FE tablets deliver iron to the roots, iron is the most important trace element for aquarium plants. Many plants absorb iron only through the roots, pressing the FE tablets into the soil enriches the nutrient medium with high-quality iron, for healthy and brilliant plant growth.

Iron capsules for the aquarium base, provides iron nutrition directly to the roots of the plants.

Iron deficiency causes growth problems, especially Echinodorus, Cryptocoryne and red plants need extra iron.

Package contains 10 tablets: Use: Every 6 months, insert 1 tablet per 10 cm<sup>2</sup> of soil surface, deep into the soil, close to the roots of plants.

**COLOMBO FLORA FE TABS 10X.**

S.R.P.

**€9,99**

Art. no.: A5010150



8 715897 243967

# Plant NPF System.

You take good care of your aquarium plants and regularly apply plant food. But which nutrients do your plants really use? This is different in every aquarium. That's why Colombo has developed the NPF Plant System!

By testing, you will know exactly which nutrients are needed and then add them accordingly. This prevents overfeeding and unwanted algae growth.

**Use the 3 test kits developed by Colombo to measure Nitrate (Nitro), Phosphorus (Phospho) and Iron (Ferro) levels in aquarium water. Use the test kits to regularly measure the Nitrate, Phosphate and Ferro values of the water. Then add the exact amount of Colombo Nitro, Phospho and Ferro nutrition using the handy dosing pump on the bottle. This keeps these 3 crucial nutrient values at the right level and your plants have perfect nutrition, without too much nutrition which encourages algae growth. It's that simple.**



**Flora Nitro**

PRO AQUA SCAPE

**New.**



1 10ml  
2 5 drops  
3 5 drops  
4 2x  
5 20 secs.  
6

Professional drip test with adapted measuring range for precise determination of nitrate value for fertilisation of aquarium plants.

**Test range Nitrate 0 – 30 mg/l**

The handy visualised instructions, included test tubes and accessories make testing easy.

The contents in the pack are sufficient for 40 tests

Colombo Flora Nitro (NO<sub>3</sub>)

0,0 mg/l
5,0 mg/l
10,0 mg/l
15,0 mg/l
20,0 mg/l
30,0 mg/l

Nr. 42892

**COLOMBO FLORA NITRO TEST.** **New.**

S.R.P. **€12,99**

Art. no.: A5010500



8 715897 342592





**Flora Phospho**

PRO AQUA SCAPE

**New.**



1 10 ml  
2 5 drops  
3 2 drops  
4 2 min  
5

Professional drop test with adapted measuring range for precise determination of phosphate value for fertilising aquarium plants.

**Test range Phosphate 0.03 – 0.8 mg/l**

The handy visualised instructions, included test tubes and accessories make testing easy.

The contents in the pack are sufficient for 40 tests

Colombo Flora Phospho (PO<sub>4</sub>)

0,20 mg/l
0,40 mg/l
0,60 mg/l
0,80 mg/l
1,00 mg/l
1,50 mg/l

Nr. 42898

**COLOMBO FLORA PHOSPHO TEST.** **New.**

S.R.P. **€13,99**

Art. no.: A5010505



8 715897 342608



**Flora Ferro**

PRO AQUA SCAPE

**New.**



1 10 ml  
2  
3 5 drops  
4

Professional drop test with adapted measuring range for precise determination of iron value for fertilisation of aquarium plants.

**Test range Iron 0.05 – 0.75 mg/l**

The handy visualised instructions, included test tubes and accessories make testing easy.

The contents in the pack are sufficient for 40 tests

Colombo Ferro Iron (Fe)

0,05 mg/l
0,10 mg/l
0,15 mg/l
0,25 mg/l
0,50 mg/l
0,75 mg/l

Nr. 42815

**COLOMBO FLORA FERRO TEST.** **New.**

S.R.P. **€14,99**

Art. no.: A5010510



8 715897 342615



## What is required for beautiful plants?

The following 3 factors must be in balance: light, CO<sub>2</sub> and nutrition. The factor that is least available in this 3-unit limits plant growth and thus creates room for algae growth.

**Modern LED lighting** can meet the light requirements of plants. When buying lamps, pay attention to the PAR value of the lighting, which is the light your plants use for growth. We recommend PAR +200.

CO<sub>2</sub> should be administered with a CO<sub>2</sub> system. Colombo has various systems for every size aquarium and budget. Install a Colombo CO<sub>2</sub> indicator to make sure you always have the optimum CO<sub>2</sub> level in your aquarium.

Proper nutrition starts with a good nutrient bed when you set up your aquarium with Colombo Nutribase and/or Florabase, for example.

However, the substrate mainly transfers nutrients to the roots, and aquarium plants in particular get a lot of nutrition from the water. The Colombo Flora Plant system is made to ensure that you always have the right amount of nutrients in the water.

In the water, 3 nutrients are important for aquarium plants: N (nitrogen), P(phosphorus) and Fe+(iron plus). Fe+ contains all the other nutrients important for plants such as iron, potassium, magnesium, manganese, zinc, cobalt, boron and many others. If you keep these 3 groups in the right concentration in your aquarium, your plants will be able to grow optimally.

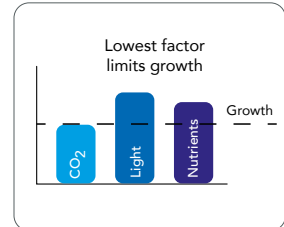
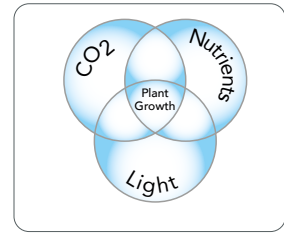

### Flora Nitro 250 ml.

Special nitrate nutrition for aquarium plants. Measure Nitrate levels with the Flora Nitro test and add Nitro nutrient as needed.

Colombo Nitro, Phospho and Ferro tests and nutrition have been developed especially for Aqua Scapers.

Add Nitrate nutrition according to the needs of the aquarium plants.

Contents: 250 ml. Dosage: 1x pumping (1,25 ml) per 25 litres of water increases Nitrate levels by 2,5 mg/l.

#### COLOMBO FLORA NITRO 250 ML.

S.R.P.

€9,99

Art. no.: A5010515



New.

### Flora Phospho 250 ml.

Special phosphate nutrition for aquarium plants. Measure phosphate levels with the Flora Phospho test and add Phospho nutrition as needed.

Colombo Nitro, Phospho and Ferro tests and nutrition have been developed especially for Aqua Scapers.

Add phosphate nutrition according to the needs of the aquarium plants.

Contents: 250 ml. Dosage: 1x pumping (1,25 ml) per 25 litres of water increases phosphate levels by 0.1 mg/l.

#### COLOMBO FLORA PHOSHO 250 ML.

S.R.P.

€9,99

Art. no.: A5010520



New.

### Flora Ferro 250 ml.

Special iron nutrition for aquarium plants. Measure the iron content with the Flora Ferro test and add Ferro nutrition as needed.

Colombo Nitro, Phospho and Ferro tests and nutrition have been developed especially for Aqua Scapers.

Add Iron nutrition according to the needs of the aquarium plants.

Contents: 250 ml. Dosage: 1x pumping (1,25 ml) per 25 litres of water increases iron levels by 0,05 mg/l.

#### COLOMBO FLORA FERRO 250 ML.

S.R.P.

€9,99

Art. no.: A5010525



New.

# CO<sub>2</sub> Basic Set.

Plants need CO<sub>2</sub> for their growth. During the day, when there is light, plants absorb CO<sub>2</sub> and produce oxygen. During the night this process reverses, CO<sub>2</sub> is released and oxygen absorbed.



## CO<sub>2</sub> Basic Set.

The CO<sub>2</sub> Basic Set provides an easy way to add CO<sub>2</sub> to small aquariums. Fill the diffuser with CO<sub>2</sub> and contact with the water absorbs the CO<sub>2</sub> gas.

Handy CO<sub>2</sub> basic set for small aquariums, ready to use in minutes.

Order refill bottles from your dealer so you can continue dosing CO<sub>2</sub> inexpensively when the first bottle is empty.

Contents 12 grams of CO<sub>2</sub>, check the CO<sub>2</sub> content of the aquarium water with the CO<sub>2</sub> indicator.

### COLOMBO CO2 KIT BASIC.

S.R.P.

€14,49

Art. no.: A5010175



8 715897 244018



## CO<sub>2</sub> Basic Set Refill.

Colombo CO<sub>2</sub> Basic Set refill, pressure bottle with 12 grams of CO<sub>2</sub>

Also suitable for the Colombo CO<sub>2</sub> basic set

Check the CO<sub>2</sub> content of the aquarium water with the CO<sub>2</sub> indicator, so you know whether you are dosing enough CO<sub>2</sub> or need to adjust the dosage.

Contents 12 grams of CO<sub>2</sub>.

### COLOMBO CO2 BASIC REFILL 12 GRAM.

S.R.P.

€6,79

Art. no.: A5010180



8 715897 244025



## CO<sub>2</sub> Advance Set.

The Colombo CO<sub>2</sub> advance set consists of a pressure cylinder containing 95 grams of CO<sub>2</sub>, a pressure regulator, a 3-in-1 diffuser and all connections. The pressure regulator controls the amount of CO<sub>2</sub> flowing into the diffuser. Inside the diffuser, the built-in bubble counter allows you to see how many CO<sub>2</sub> bubbles are released in a given time. The diffuser produces very fine bubbles so that the CO<sub>2</sub> gas is well absorbed by the water.

Complete CO<sub>2</sub> set for aquariums up to 100 litres

With the adaptor available as an accessory, you can upgrade this set and use a large 800 or 1200-gram CO<sub>2</sub> bottle.

Pressure regulator with 5/8-18 UNF thread and 95g CO<sub>2</sub> cylinder.

### COLOMBO CO2 KIT ADVANCE 95GR.

S.R.P.

**€114,99**

Art. no.: A5010185



8 715897 244032

## 95 gram CO<sub>2</sub> cylinder.

CO<sub>2</sub> cylinder for the Colombo CO<sub>2</sub> advance set. Contents 95 grams, for 1-time use.

Refill for Colombo CO<sub>2</sub> Advance set

With 5/8-18 UNF thread.

Contents 95 grams of CO<sub>2</sub>.

### COLOMBO CO2 ADVANCE CYLINDER 95 GRAM.

S.R.P.

**€18,79**

Art. no.: A5010190



8 715897 244186

## Advance pressure regulator.

CO<sub>2</sub> advance pressure regulator for 95-gram CO<sub>2</sub> capsules, for precise control of CO<sub>2</sub> release.

Pressure reducer with intermediate chamber for constant CO<sub>2</sub> release

Suitable for 95-gram CO<sub>2</sub> cylinders with 5/8-18 UNF connection

### COLOMBO ADVANCE CO2 PRESSURE REGULATOR.

S.R.P.

**€75,99**

Art. no.: A5010312



8 715897 081101



## CO<sub>2</sub> Advance Set with 800 gr/1200 gr. Cylinder.

Using this adapter ring, you can use the pressure regulator of the Advance set on the 800 & 1200gram cylinder. This way, the cylinder needs to be changed less often and CO<sub>2</sub> use is almost 70% cheaper.

Makes the Colombo Advance CO<sub>2</sub> set suitable for the Colombo 800 or 1200 gram CO<sub>2</sub> bottle.

Save up to 70% on the cost of CO<sub>2</sub> usage with our 800 and 1200g CO<sub>2</sub> cylinders.

Adapter from 5/8-18 UNF to M10 x1.



Adapter ring from 5 / 8-18 UNF (Advance regulator) to M10 (800 & 1200 gr. CO<sub>2</sub> fles).

### COLOMBO CO2 ADAPTOR 95 -> 800&1200 GRAM.

S.R.P.

**€12,99**

Art. no.: A5010200



8 715897 244209



## CO<sub>2</sub> Profi Set:

The CO<sub>2</sub> Profi Set is a professional CO<sub>2</sub> system and includes a pressure regulator, a 3-in-1 diffuser, a disposable bottle with 800 grams of CO<sub>2</sub> and all connections. You can expand the CO<sub>2</sub> Profi Set with a solenoid valve, which is available as an accessory from your dealer.

Professional CO<sub>2</sub> set for aquaria from 50 to 400 litres

The iron pressure cylinder is for single use, the cylinder is fully recyclable and therefore good for the environment. Supplied with M10 schrader valve.

Contents 800 g CO<sub>2</sub> for weeks of CO<sub>2</sub> administration

### COLOMBO CO2 PROFI SET 800 GRAM.

S.R.P.

€177,49

Art. no.: A5010189

1



8 715897 285295



## CO<sub>2</sub> Cilinder 800 grams:

Pressure cylinder for 1-time use with a capacity of 800 grams of CO<sub>2</sub> with M10 schrader valve. Suitable for the Colombo CO<sub>2</sub> profi set or with adaptor ring for the Colombo CO<sub>2</sub> advance set and other brands.

Economical refill for CO<sub>2</sub> Profi set, or with the special adapter ring on the advance set

The iron pressure cylinder is for single use, the cylinder is fully recyclable and thus good for the environment.

Contents 800 g CO<sub>2</sub> for weeks of CO<sub>2</sub> administration

### COLOMBO CO2 CYLINDER 800 GRAM.

S.R.P.

€44,99

Art. no.: A5010195



8 715897 244193



## CO<sub>2</sub> Cilinder 1200 grams:

Pressure cylinder for 1-time use with a capacity of 1200 grams of CO<sub>2</sub> with M10 schrader valve. Suitable for the Colombo CO<sub>2</sub> profi set or with adaptor ring for the Colombo CO<sub>2</sub> advance set and other brands.

Economical refill for CO<sub>2</sub> Profi set, or with the special adapter ring on the advance set

The iron pressure cylinder is for single use, the cylinder is fully recyclable and thus good for the environment.

Contents 1200 g CO<sub>2</sub> for weeks of CO<sub>2</sub> administration

### COLOMBO CO2 CYLINDER 1200 GRAM.

S.R.P.

€49,99

Art. no.: A5010197



8 715897 343094



## Solenoid valve.

The system can be optionally equipped with a solenoid valve.

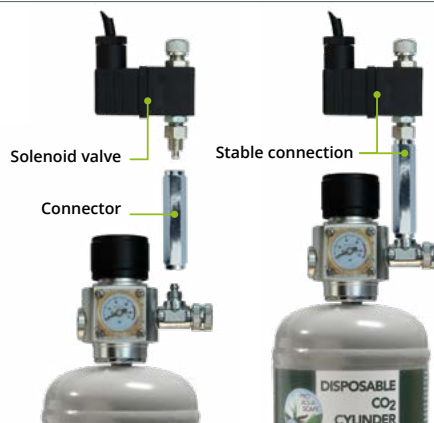

As plants only absorb CO<sub>2</sub> during the day, the supply can be stopped at night. By installing the solenoid valve, this can be done automatically using a time switch. The solenoid valve pays for itself, as you save a lot on CO<sub>2</sub> cylinders!

Save 50% or more CO<sub>2</sub> with this electric solenoid valve.

Easy to switch with a timer.

230 volt, 2 watts. 1.5-metre cable with RA Schuko plug, 4-6 mm connection with fixing bolt.

### COLOMBO CO2 SOLENOID CONNECTOR.

S.R.P.

€13,49

Art. no.: A5010255



8 715897 319600

### COLOMBO CO2 SOLENOID VALVE.

S.R.P.

€67,49

Art. no.: A5010205



8 715897 244216



## CO<sub>2</sub> Reactor.

**Make your own CO<sub>2</sub> with 2 components. No more changing pressure bottles!**

With the Colombo CO<sub>2</sub> reactor you can easily make CO<sub>2</sub> yourself with two components! Instead of buying or changing pressure bottles, the empty cylinder the 2-component can easily be refilled with pure CO<sub>2</sub> gas. The cylinder is made of 314 stainless steel. Complete set with bottle holder, pressure regulator, solenoid valve, bubble counter, non-return valve, outlet valve, accessories and spare parts.

**Make your own CO<sub>2</sub> with 2 components. No more changing pressure bottles!**

**How does it work? Open the cylinder and add the 2-components and 300 ml of water, close the bottle with the pressure regulator, the chemical reaction creates around 105 grams of CO<sub>2</sub> gas in 30 minutes.**

**Note: The refill is not included, buy it separately from your dealer; Colombo CO<sub>2</sub> reactor refill A5010340**

### COLOMBO CO2 REACTOR KIT 2,3L.

S.R.P.  
**€239,99**

Art. no.: A5010325



### COLOMBO CO2 REACTOR SET SPARE DIFFUSER.

S.R.P.  
**€7,99**

Art. no.: A5010260



## CO<sub>2</sub> reactor Parts:

1. Pressure regulator
2. Pressure gauge
3. Pressure relief valve
4. Hose connector
5. Bubble counter
6. Bubble counter base
7. Solenoid
8. Adjustment knob
9. Cable connector
10. Stainless steel cylinder
11. Moisture filter
12. Diffusor
13. Hose
14. Hose clamp with suction cups
15. Non-return valve
16. Cylinder base

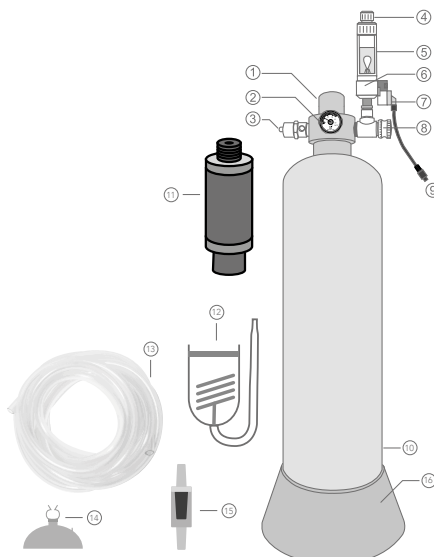

## CO<sub>2</sub> Reactor Refill.

Special 2-component refill for the Colombo CO<sub>2</sub> reactor, contains 3 sets of component A and B that allow you to fill the CO<sub>2</sub> reactor 3 times.

**Make your own CO<sub>2</sub> with 2 components. No more changing pressure bottles!**

**How does it work? Open the cylinder and add the 2-components and 300 ml of water, close the bottle with the pressure regulator, the chemical reaction creates around 105 grams of CO<sub>2</sub> gas in 30 minutes.**

**1 pack is thus sufficient to make about 315 grams of CO<sub>2</sub>.**

### COLOMBO CO2 REACTOR REFILL 1,2 KG.

S.R.P.  
**€17,99**

Art. no.: A5010340



## Profi pressure regulator.

Pressure regulator for M10x1 connection. With double chamber, separate fine control, an open and close valve and a mano meter.

**Suitable for Colombo 800 and 1200 gram cylinder.**

**Due to the double chamber, the amount of CO<sub>2</sub> added always remains the same.**

**M10x1 connection.**

### COLOMBO CO2 PROFI REGULATOR M10.

S.R.P.  
**€109,99**

Art. no.: A5010217



### COL. CO2 PROFI O-RING REGULATOR 2X.

S.R.P.  
**€3,99**

Art. no.: A5010219





## 3 in 1 diffuser.

With the 3 in 1 diffuser, you have a check valve, bubble counter and diffuser in one device. Available in Medium and Large models.

3 in 1 space-saving CO<sub>2</sub> diffuser.

Equipped with bubble counter for simple dosing.

Made of crystal-clear acrylic, it has the optics of glass but is not as breakable!

### COLOMBO CO2 3-1 DIFFUSER MEDIUM.

S.R.P.  
**€14,99**

Art. no.: A5010208



### COLOMBO CO2 3-1 DIFFUSER LARGE.

S.R.P.  
**€16,79**

Art. no.: A5010210



## Scaper CO<sub>2</sub> Diffuser.

Professional CO<sub>2</sub> Diffuser, perfect for Aquascaping.

Professional CO<sub>2</sub> Diffuser, perfect for Aquascaping. Length 40 cm, the diffuser should be placed as deep as possible in the aquarium. Check the height of your aquarium and choose the right model.

### Spare Diffuser.



Made of crystal-clear acrylic with the optics of glass but not as fragile.

Available in 25, 35 and 40 cm, with catchable diffuser available as an accessory from your dealer.

For aquaria between 35-40 cm high



### SCAPER CO2 DIFFUSER 25 CM.

S.R.P.  
**€31,99**

Art. no.: A5010225



### SCAPER CO2 DIFFUSER 40 CM.

S.R.P.  
**€34,99**

Art. no.: A5010235



### SCAPER CO2 DIFFUSER 35 CM.

S.R.P.  
**€32,99**

Art. no.: A5010230



### SCAPER CO2 SPARE DIFFUSER.

S.R.P.  
**€7,99**

Art. no.: A5010237



Adapter ring to make pressure regulators with an M10x1.25 thread suitable for the Colombo 800 or 1200 gram CO<sub>2</sub> bottle.

Dennerle and other brands uses pressure regulators with an M10x1.25 thread.

### COLOMBO CO2 ADAPTOR DENNERLE 500GR.

S.R.P.  
**€12,99**

Art. no.: A5010213



### COLOMBO CO2 O-RING FOR REGULATOR 2X.

S.R.P.  
**€3,99**

Art. no.: A5010215

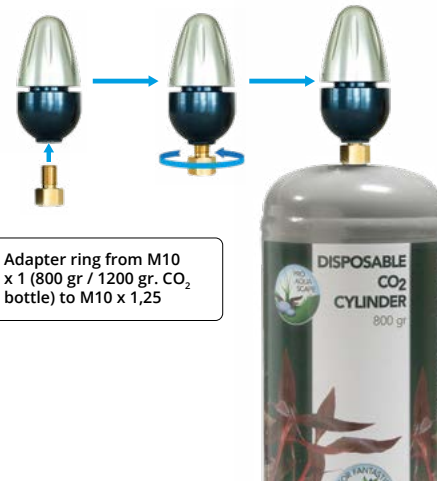

Adapter ring from M10 x 1 (800 gr / 1200 gr. CO<sub>2</sub> bottle) to M10 x 1,25



## Adapter (Dennerle).

The adapter ring allows you to use a pressure regulator with an M10x1.25 thread (Dennerle) on the Colombo 800 and 1200 gram CO<sub>2</sub> bottle with an M10x1.0 connection.

## CO<sub>2</sub> indicator.

The CO<sub>2</sub> indicator is an indispensable tool when using a CO<sub>2</sub> system. The indicator shows the CO<sub>2</sub> value, so you know how much CO<sub>2</sub> is in the aquarium water and can adjust the CO<sub>2</sub> system to the correct amount.

CO<sub>2</sub> indicator for all sizes of aquariums.

By measuring the CO<sub>2</sub> value you can set the CO<sub>2</sub> system properly you save CO<sub>2</sub>.

Supplied complete with suction cup and 2x10 ml reagents.



### COLOMBO CO2 INDICATOR.

S.R.P.  
**€16,99**

Art. no.: A5020295





# Coral salt, Test kits, Additives, Pest control.



For a successful Marine Aquarium.

# Marine test lab.

## All essential tests in one case.

Our reliable dripping test for Carbonate hardness (KH), Calcium content (Ca), Magnesium content (Mg), Nitrate level and Phosphate level packed in a handy plastic case with a custom made interior to organise the storage of your test kits. The components from the Colombo marine test sets can be used to complement empty bottles or used materials.

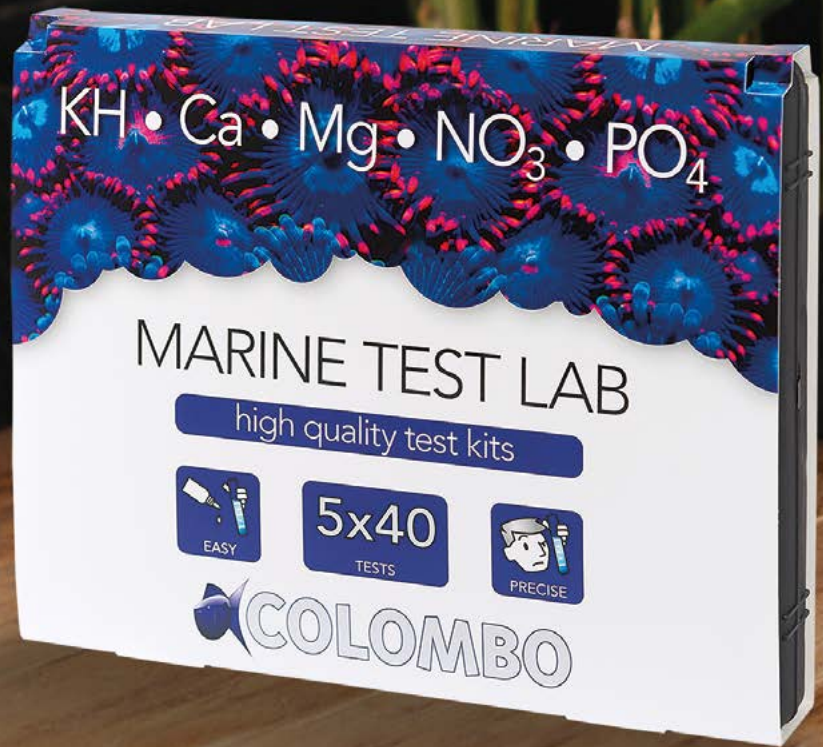

◀ INDEX



Carbonate Hardness



Calcium

Inclusief



Magnesium



Nitrate



Phosphate

### Marine test lab.

Test case with the most popular drip tests for marine water. Contains professional tests for Carbonate hardness, Calcium, Magnesium, Nitrate and Phosphate.

Complete with all necessary accessories and visualised operating instructions. Packed in sturdy plastic case.

Consumed test materials can be replenished with the loose Colombo seawater tests.

With each test, 40 tests can be done.

**COLOMBO MARINE TEST LAB (KH-CA-MG-NO3-PO4).**

S.R.P.

**€62,99**

Art. No.: N5060625

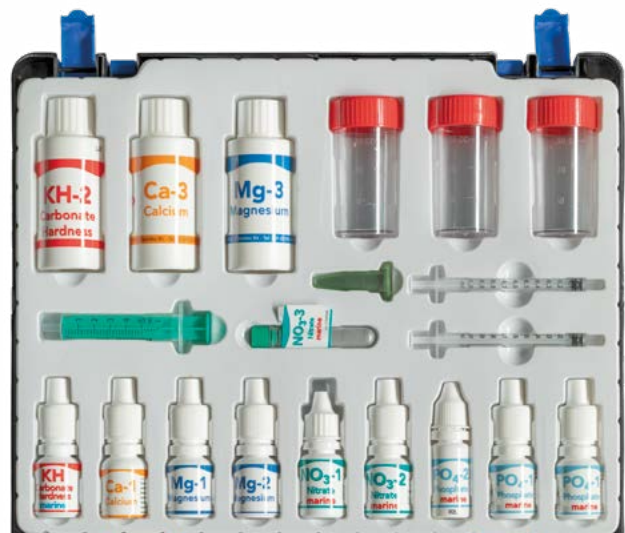



## Correct water parametres are essential for a succesful marine aquarium.

Complete range of drip tests for marine aquariums. Tests available for pH - KH - GH - Ammonia - Nitrite - Nitrate - Phosphate. With the quick test strip you can test pH - KH - GH - Nitrite - Nitrate and Chlorine value. The tests are easy to use and provide a reliable measurement result. Whichever test you choose, regular testing of the water is essential to maintain your marine aquarium.

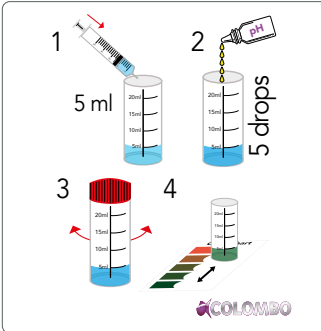
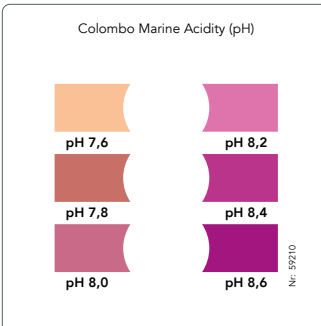
Professional drop test for precise determination of pH in seawater.

**Test range pH 7.6 - 8.6**



The handy visualised instructions for use, included test tubes and accessories make testing easy.

The contents in the pack are sufficient for 40 tests

**COLOMBO MARINE PH TEST.**  
S.R.P. **€7,99**  
Art. No.: N5060510

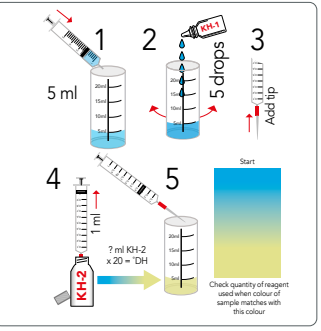

8 715897 259210





Professional drop test for precise determination of KH in seawater.

**EASY** **PRECISE** **40 TESTS**

**Instructions.**  
Instructions are on the back of each test kit.

**COLOMBO MARINE KH TEST.**  
S.R.P. **€9,79**  
Art. No.: N5060515



4 8 715897 259227

INDEX





Professional drop test for precise determination of Calcium content in seawater.



**EASY** **PRECISE** **40 TESTS**

**Instructions.**  
Instructions are on the back of each test kit.

**COLOMBO MARINE CALCIUM TEST.**  
S.R.P. **€13,99**  
Art. No.: N5060540

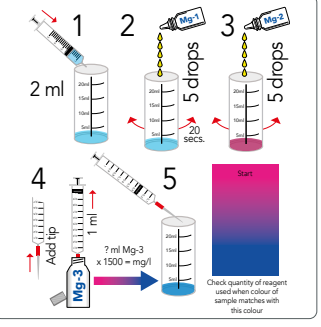

8 715897 259272





Professional drop test for precise determination of Magnesium content in seawater.

**EASY** **PRECISE** **40 TESTS**

**Instructions.**  
Instructions are on the back of each test kit.

**COLOMBO MARINE MAGNESIUM TEST.**  
S.R.P. **€13,99**  
Art. No.: N5060545



4 8 715897 259289

Scan for QR code for info.







Colombo Marine Ammonia (NH<sub>3</sub>)

0,0 mg/l
0,25 mg/l
0,50 mg/l
1,0 mg/l
2,0 mg/l
5,0 mg/l

Nr. 59234

**Test range ammonia: 0 - 5 mg/l**

The handy visualised instructions for use, included test tubes and accessories make testing easy.

The contents in the pack are sufficient for 40 tests

**COLOMBO MARINE AMMONIA TEST.**  
S.R.P.  
**€11,59**  
Art. No.: N5060520



8 715897 259234



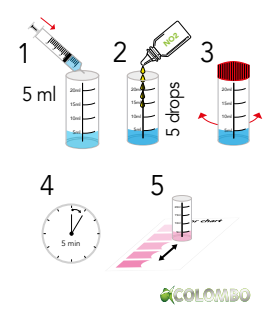

Colombo Marine Nitrite (NO<sub>2</sub>)

0 mg/l
0,25 mg/l
0,50 mg/l
0,75 mg/l
1,00 mg/l
2,00 mg/l

Nr. 59241

**Test range nitrite: 0 - 2 mg/l**

The handy visualised instructions for use, included test tubes and accessories make testing easy.

The contents in the pack are sufficient for 40 tests

**COLOMBO MARINE NITRITE TEST.**  
S.R.P.  
**€8,19**  
Art. No.: N5060525



8 715897 259241



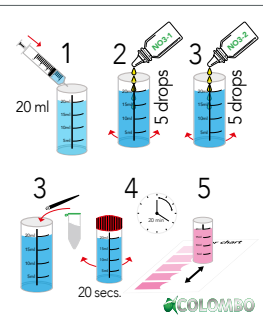

Colombo Marine Nitrate (NO<sub>3</sub>)

0,0 mg/l
0,25 mg/l
0,50 mg/l
1,0 mg/l
2,0 mg/l
4,0 mg/l

Nr. 59258

**Test range Nitrate 0 - 4 mg/l**

The handy visualised instructions for use, included test tubes and accessories make testing easy.

The contents in the pack are sufficient for 40 tests

**COLOMBO MARINE NITRATE TEST.**  
S.R.P.  
**€11,99**  
Art. No.: N5060530



8 715897 259258



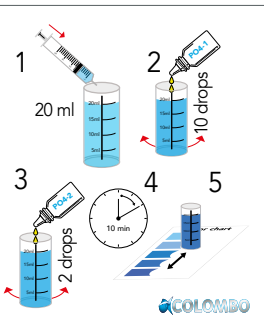

Colombo Marine Fosfaat (PO<sub>4</sub>)

0,03 mg/l
0,06 mg/l
0,10 mg/l
0,20 mg/l
0,40 mg/l
0,80 mg/l

Nr. 59265

**Test range Phosphate 0.03 - 0.8 mg/l**

The handy visualised instructions for use, included test tubes and accessories make testing easy.

The contents in the pack are sufficient for 40 tests

**COLOMBO MARINE PHOSPHATE TEST.**  
S.R.P.  
**€12,99**  
Art. No.: N5060535



8 715897 259265



Scan for QR code for info.



Color	Concentration (mg/l)
Orange	0 mg/l
Light Orange	0,02 mg/l
Yellow-Orange	0,04 mg/l
Yellow	0,06 mg/l
Light Yellow	0,08 mg/l
Very Light Yellow	0,10 mg/l

**Test range Iodine 0 - 0.1 mg/l**

The handy visualised instructions for use, included test tubes and accessories make testing easy.

The contents in the pack are sufficient for 40 tests

**COLOMBO MARINE IODINE TEST (COLOUR 1).**  
S.R.P. **€14,49**  
Art. No.: N5060555

**Professional drop test for precise determination of potassium levels in seawater.**

**EASY PRECISE TESTS**

**Instructions.**  
Instructions are on the back of each test kit.

**COLOMBO MARINE POTASSIUM TEST (COLOUR 2).**  
S.R.P. **€25,79**  
Art. No.: N5060550

INDEX

Color	Concentration (mg/l)
Light Pink	0,05 mg/l
Pink	0,10 mg/l
Light Purple	0,15 mg/l
Purple	0,25 mg/l
Dark Purple	0,50 mg/l
Very Dark Purple	0,75 mg/l

**Test range Iron 0.05 - 0.75 mg/l**

The handy visualised instructions for use, included test tubes and accessories make testing easy.

The contents in the pack are sufficient for 40 tests

**COLOMBO MARINE IRON TEST (COLOUR 3).**  
S.R.P. **€13,49**  
Art. No.: N5060560

Color	Concentration (mg/l)
White	0 mg/l
Light Blue	0,25 mg/l
Light Blue	0,50 mg/l
Medium Blue	1,00 mg/l
Dark Blue	2,00 mg/l
Very Dark Blue	4,00 mg/l

**Silicate test range: 0 - 4 mg/l**

The handy visualised instructions for use, included test tubes and accessories make testing easy.

The contents in the pack are sufficient for 40 tests

**COLOMBO MARINE SILICATE TEST.**  
S.R.P. **€12,49**  
Art. No.: N5060650

# Test Stirrer.



The Colombo test stirrer is the perfect aid when testing water. The stirrer mixes the water sample so you have both hands free to carefully add the reagent. Especially with tests that work on the so called titration principle where the colour of the sample changes, the stirrer helps for easier and more accurate results.

De Colombo test stirrer is de ideale hulp bij het testen van het water. De stirrer houdt het watermonster in beweging zodat u beide handen vrij hebt om de reagent zorgvuldig te kunnen toedienen. Bij test die werken op basis van het zgn. titratie principe zorgt de stirrer voor gemakkelijk testen en nauwkeurige resultaten.

◀◀  
INDEX

## Test Stirrer.

The test stirrer keeps the water sample moving so you have both hands free to carefully administer the reagents.

**Recommended for all tests operating on the titration principle.**

**Indispensable tool for precision testing.**

**Requires 2 AA batteries (not included)**

### COLOMBO MARINE TEST STIRRER.

S.R.P.

**€34,99**

Art. No.: N5060690



8 715897 306846

### COLOMBO STIRRER REPLACEMENT MAGNET 2X.

S.R.P.

**€3,49**

Art. No.: N5060699



8 715897 311062



**Marine Bacto.**  
Complete & quick build up of biology

Bacto contains a unique blend of specially selected bacteria that provide a complete and rapid build-up of biology in the marine aquarium.

**COLOMBO MARINE BACTO 500 ML.**

S.R.P.  
**€16,79**

Art. No.: N5060400



At the start, rapid biological build-up is very important to avoid problems such as algae growth as much as possible.

After starting the aquarium, add Bacto weekly for optimal biology in which fish and invertebrates thrive optimally.

Contents 500 ml, sufficient for starting up 250 litres

Contents 1000 ml, sufficient for starting 500 litres

**COLOMBO MARINE BACTO 1000 ML.**

S.R.P.  
**€24,99**

Art. No.: N5060405



**KH Plus.**  
For optimal KH values

Liquid KH booster to maintain an optimal KH, between 8 and 12°DH. Test the KH value and add KH-plus to compensate for consumption.

**COLOMBO MARINE KH+ 500 ML.**

S.R.P.  
**€13,79**

Art. No.: N5060410



This concentrated formula provides the maximum KH increase without precipitation.

Ready-to-use liquid, you can dose it directly into your marine aquarium

Contents 500 ml increases KH by 4° in 1,250 ltr

Contents 1000 ml increases KH by 4° in 2,500 ltr

Contents 2500 ml increases KH by 4° in 6,250 ltr

**COLOMBO MARINE KH+ 1000 ML.**

S.R.P.  
**€21,99**

Art. No.: N5060415



**COLOMBO MARINE KH+ 2500 ML.**

S.R.P.  
**€39,99**

Art. No.: N5060417



**Bacto Balls.**

Colombo bacto balls contain a unique blend of specially selected bacteria that provide complete and stable biology in the marine aquarium.

The special bio polymer balls ensure even release.

500 ml, sufficient for 100 litres of water for 40 weeks.

1000 ml, sufficient for 200 litres of water for 40 weeks.

**COLOMBO MARINE BACTO BALLS 500 ML.**

S.R.P.  
**€25,79**

Art. No.: N5060630



**COLOMBO MARINE BACTO BALLS 1000 ML.**

S.R.P.  
**€36,79**

Art. No.: N5060635



**Bacto Balls Dispenser.**

The handy dispenser allows easy application of the Bacto Balls and easy removal of residues from the aquarium after use.

You easily mount and remove the dispenser in your sump or aquarium with the suction cups provided

**COLOMBO MARINE BACTO BALL DISPENSER.**

S.R.P.  
**€6,99**

Art. No.: N5060640



**KH Plus Powder.**

KH booster to maintain an optimum KH, between 8 and 12°DH. Test the KH value and add KH-plus to compensate for consumption.

This concerns the economical powder form. With this, a stock solution can be made to maintain magnesium levels very economically.

Contains high-quality, high-purity ingredients for efficient and safe use.

Contents 1000 ml = approx. 1.3 kg. Increases the KH value by 4°DH in 10,000 litres of water.

**COLOMBO MARINE KH+ POWDER 1.000 GR..**

S.R.P.  
**€21,99**

Art. No.: N5060420





## Calcium Plus.

Additives from natural seawater!

Liquid Calcium addition to maintain an optimum value, between 410 and 440 mg/l. Test the Calcium value and add Calcium plus to compensate for consumption.

**COLOMBO MARINE CALCIUM + 500 ML.**

S.R.P.

**€13,79**

Art. No.: N5060425



Contains ingredients extracted from natural seawater by solar evaporation! This offers great advantages over products using chemical or mined raw materials

**COLOMBO MARINE CALCIUM + 1000 ML.**

S.R.P.

**€22,99**

Art. No.: N5060430



Contents 500 ml, increases Calcium content by 50 mg/l in 500 litres of water.

**COLOMBO MARINE CALCIUM + 2500 ML.**

S.R.P.

**€39,99**

Art. No.: N5060433



Contents 500 ml, increases Calcium content by 50 mg/l in 500 litres of water.

Contents 500 ml, increases Calcium content by 50 mg/l in 500 litres of water.



## Magnesium.

Additives from natural seawater!

Liquid Magnesium addition to maintain an optimum value, between 1250 and 1300 mg/l. Test the Magnesium value and add Magnesium plus to compensate for consumption.

**COLOMBO MARINE MAGNESIUM+ 500 ML.**

S.R.P.

**€13,79**

Art. No.: N5060440



Ready-to-use liquid to add magnesium, it can be added directly to seawater.

**COLOMBO MARINE MAGNESIUM+ 1000 ML.**

S.R.P.

**€22,99**

Art. No.: N5060445



Contains ingredients extracted from natural seawater by solar evaporation! This offers great advantages over products using chemical or mined raw materials

Contents 500 ml, increases Magnesium content by 175 mg/l in 500 litres of water.

Contents 1000 ml, increases Magnesium content by 175 mg/l in 1000 litres of water.



## Calcium Plus.

Additives from natural seawater!

Liquid Calcium addition to maintain an optimum value, between 410 and 440 mg/l. Test the Calcium value and add Calcium plus to compensate for consumption.

This concerns the economical powder form. This can be used to make a stock solution to maintain calcium levels very economically.

Contains ingredients extracted from natural seawater by solar evaporation! This offers great advantages over products using chemical or mined raw materials

Contents 1000 ml = approx. 1.0 kg. Increases the calcium content by 115 mg/l in 1000 litres of water

**COLOMBO MARINE CALCIUM + POWDER 1L.**

S.R.P.

**€22,99**

Art. No.: N5060435



## Magnesium Plus.

Additives from natural seawater!

Liquid Magnesium addition to maintain an optimum value, between 1250 and 1300 mg/l. Test the Magnesium value and add Magnesium plus to compensate for consumption.

This concerns the economical powder form. With this, a stock solution can be made to maintain magnesium levels very economically.

Contains ingredients extracted from natural seawater by solar evaporation! This offers great advantages over products using chemical or mined raw materials

Contents 1000 ml = approx. 1.3 kg. Increases the magnesium content by 250 mg/l in 250 litres of water

**COLOMBO MARINE MAGNESIUM+ POWDER 1L.**

S.R.P.

**€22,99**

Art. No.: N5060450





## Nitrate Ex. Nitrate and phosphate removal.

Nitrate Ex is a nutrient for bacteria in marine water that can break down nitrate. By adding Nitrate Ex, Nitrate is broken down efficiently and naturally.

Bacteria that break down nitrate cannot develop properly without Nitrate Ex. After a few weeks, the bacterial colony is sufficiently developed and you will be able to observe a clear reduction in nitrate.

Daily dosing, the use of a dosing pump is recommended.

Contents 500 ml, sufficient to treat 250 litres of water for 40 days.

Contents 1000 ml, sufficient to treat 500 litres of water for 40 days.

Capacity 2500 ml, sufficient to treat 625 litres of water for 80 days.

### COLOMBO MARINE ALGAE NITRATE EX 500 ML.

S.R.P.  
**€12,59**

Art. No.: N5060455



### COLOMBO MARINE ALGAE NITRATE EX 1000 ML.

S.R.P.  
**€21,49**

Art. No.: N5060460



### COLOMBO MARINE ALGAE NITRATE EX 2500 ML.

S.R.P.  
**€38,49**

Art. No.: N5060463



Scan for QR  
code for  
info.



## NP Pellets. Nitrate and phosphate removal.

NP pellets provide a nutrient for bacteria that can break down nitrate in seawater.

By using NP pellets, Nitrate is efficiently degraded naturally.

Preferably use in a moving bed filter

Contents 1000 ml, sufficient for 500 - 2000 litres of water.

### COLOMBO MARINE NP PELLETS 1.000 ML.

S.R.P.  
**€62,99**

Art. No.: N5060565



## Phosphate EX. Nitrate and phosphate removal.

Phosphates in seawater are easily removed with Phosphate Ex.

With one dose, the desired amount of phosphate can be removed immediately.

Our unique formula offers unparalleled results.

Contents 500 ml, sufficient to remove 2,500 mg of phosphate.

Contents 1000 ml, sufficient to remove 5000 mg of phosphate.

### COLOMBO MARINE ALGAE PHOSPHATE EX 500 ML.

S.R.P.  
**€14,79**

Art. No.: N5060465



### COLOMBO MARINE ALGAE PHOSPHATE EX 1000 ML.

S.R.P.  
**€22,99**

Art. No.: N5060470



## Nitrate Plus. Adding Nitrate and Phosphate

Nitrate Plus is a ready-to-use liquid to replenish nitrate levels in marine water.

In aquaria with very large numbers of corals, nitrate deficiency can occur, which can be easily supplemented with Nitrate Plus.

Powerful formula

Contents 500 ml, sufficient to increase nitrate levels by 1 mg/l in 500 litres of water.

Contents 1000 ml, sufficient to increase nitrate levels by 1 mg/l in 1000 litres of water.

### COLOMBO MARINE NITRATE PLUS 500 ML.

S.R.P.  
**€21,59**

Art. No.: N5060595



### COLOMBO MARINE NITRATE PLUS 1000 ML.

S.R.P.  
**€12,49**

Art. No.: N5060600

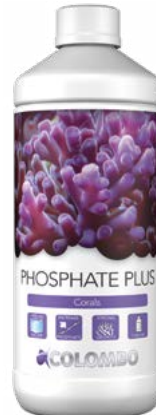

## Phosphate Plus. Adding nitrate and phosphate.

Phosphate Plus is a ready-to-use liquid to replenish phosphate levels in seawater.

In aquaria with very large numbers of corals, phosphate deficiency can occur, which can be easily supplemented with Phosphate Plus.

Powerful formula

Contents 500 ml, sufficient to increase phosphate levels by 0.1 mg/l in 500 litres of water.

Contents 1000 ml, sufficient to increase phosphate levels by 0.1 mg/l in 1000 litres of water.

### COL MARINE PHOSPHATE PLUS 500 ML.

S.R.P.  
**€12,59**

Art. No.: N5060605



### COLOMBO MARINE PHOSPHATE PLUS 1000 ML.

S.R.P.  
**€21,49**

Art. No.: N5060610



# Marinepads.



◀ INDEX

## Nitrate Zorb.

Filter pads for removing nitrite and nitrate

Colombo Marine Nitrate Zorb is a premium-grade, NITRATE selective, ion-exchange resin. It removes NITRATE safely from seawater through selective ion-exchange. Our premium product works in a wide range of pH and temperature conditions. Marine Nitrate Zorb can be used in conjunction with our Marine Phosphate pads.



Removes Nitrates and reduces maintenance, great for heavily stocked aquariums.

The PADS unique round design allows unrestricted flow within the filter which is vital for the Bacteria Population.

Pack contains 3 individually sealed 100g PADS, sufficient for up to 350 liters of water, pads are effective for up to 10 weeks, load dependent. Pads can be regenerated.

COLOMBO MARINE NITRATE ZORB.

S.R.P.

€34,99

Art. No.: N5060700



8 715897 342653

New

## Phosphate Zorb.

Filter pads for removing phosphate

Colombo Marine Phosphate Zorb is a premium-grade PHOSPHATE selective ion exchange resin. It removes both ionically and chemically bound Phosphate from marine water quickly and safely through selective ion exchange. Our high-performance product works in a wide range of pH and temperature conditions, and Marine Phosphate can be used in combination with our Marine Nitrate pads.



Removes the food source from nuisance algae, as a result you get extremely clear, algae free water.

Phosphate Zorb helps reduce nuisance algae by starving it of its primary food source, Phosphates, great for heavily stocked aquariums.

Pack contains 3 individually sealed 100g PADS, sufficient for up to 1500 litres of water. Pads are effective for up to 12 weeks, load dependent.

COLOMBO MARINE PHOSPHATE ZORB.

S.R.P.

€34,99

Art. No.: N5060705



8 715897 342660

New



# Optimize colours.



## Halo Complex.

Optimize colours.

Iodine addition for seawater.

Colour-1 is iodine-based, but also contains 2 other so-called halogens, namely bromine and fluorine.

Especially important for pink colour development.

Contents 500 ml, increased iodine content by 3 mg in 500 litres of water.

**COLOMBO MARINE COLOUR 1 HALO COMPLEX (I-F) 500 ML.**

S.R.P.

**€12,59**

Art. No.: N5060475



8 715897 259142

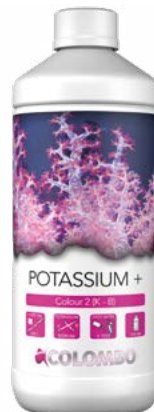

## Halo Complex.

Optimize colours.

Potassium additive for seawater.

Colour-2 is potassium-based, but also contains the element Boron.

Especially important for pink colour development.

Contents 500 ml, increased potassium content by 200 mg in 500 litres of water.

**COLOMBO MARINE COLOUR 2 POTASSIUM+ (K-B) 500 ML.**

S.R.P.

**€12,59**

Art. No.: N5060480



8 715897 259159



## Metals Plus.

Optimize colours.

Iron addition for seawater.

Colour-3 is iron-based, but also contains the many other trace elements such as manganese, cobalt and nickel.

Especially important for the development of yellow and green colours.

Contents 500 ml, increased iron content by 2 mg in 500 litres of water.

**COLOMBO MARINE COLOUR 3 METALS 500 ML (FE).**

S.R.P.

**€12,59**

Art. No.: N5060485



8 715897 259166



## Coral Vits.

Optimize colours.

Liquid additive with vitamins and trace elements for marine water.

Corals get most of their nutrition from the algae they live in symbiosis with, the zooxanthellen, but this is usually not enough for optimal growth. There are also corals that do not contain zooxanthellen, such as gorgonians. So these types of corals have to get almost all their nutrition from the surrounding water.

Colombo Coral Vits provides corals with extra nutrition, it contains nutrients such as vitamins and amino acids.

Contents 500 ml, sufficient to treat 250 litres of water for a period of 100 days.

**COLOMBO MARINE CORAL VITS 500 ML.**

S.R.P.

**€13,79**

Art. No.: N5060495



8 715897 259180

**COLOMBO MARINE CORAL VITS 1000 ML.**

S.R.P.

**€22,99**

Art. No.: N5060497



8 715897 284540



# Optimize colours.

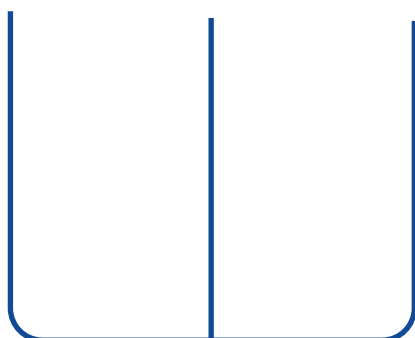

Dosage based on Calcium consumption



## All in One.

Optimize colours.

Complete all-in-one additive for trace elements in seawater.

The typical colour splendour of corals only comes to fruition when all trace elements are sufficiently present in the water. With Colombo All in One, controlled trace elements such as potassium, iodine and iron can be added.

Measure only the calcium value, based on this value the trace elements can be added in a controlled way.

Contents 500 ml, sufficient to treat 250 litres of water for a period of 100 days.

Contents 1000 ml, sufficient to treat 500 litres of water for a period of 100 days.

**COL MARINE COLOUR ALL IN ONE 500 ML.**

S.R.P.

**€13,79**

Art. No.: N5060490



**COLOMBO MARINE COLOUR ALL IN ONE 1000 ML.**

S.R.P.

**€22,49**

Art. No.: N5060492



# All Four.



Dosage based on Calcium consumption



**ALL**  
FOUR



◀ INDEX

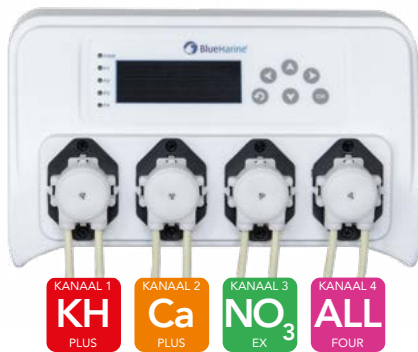

## Easy maintenance with the Colombo All4 system on a 4-channel dosing pump.

- Channel 1: Colombo KH+
- Channel 2: Colombo Ca+
- Channel 3: Colombo Nitrate Ex
- Channel 4: Colombo All Four

### All Four.

Combined additive for use with the Colombo All Four care system for marine aquariums.

Colombo All Four contains Magnesium and numerous elements important for optimal colouration such as Potassium, Iron, Iodine, etc.

Contents 1000 ml. Dosage based on Calcium consumption.

Use together with Colombo KH+, CA+ and Nitrate Ex. Dosing using a 4-channel dosing pump is recommended.

Contents 2500 ml. Dosage based on Calcium consumption.

Contents 500 ml. Dosage based on Calcium consumption.

#### COLOMBO MARINE ALL FOUR 1000 ML.

S.R.P. €21,99

Art. No.: N5060670



#### COLOMBO MARINE ALL FOUR 500 ML.

S.R.P. €13,79

Art. No.: N5060665



#### COLOMBO MARINE ALL FOUR 2500 ML.

S.R.P. €39,99

Art. No.: N5060675



# Pro Reef Salt & Marine Sand.

the use of Colombo Pro Reef salt and the Colombo additives are highly recommended by experts and professionals.

A fine natural substrate for marine aquaria. A perfect medium for maximum biological activity.



## Pro Reef Salt.

Colombo Pro Reef Salt is extracted from the coral sea and therefore contains trace elements in the same proportions as in the sea. Because of its origin, Colombo Pro Reef Salt differs greatly from most other marine aquarium salts. At least 85% of the ingredients are derived from natural seawater and extracted by natural evaporation. Many hobbyists subscribe to the benefits of a natural product, which is why experts wholeheartedly recommend using Reef Pro salt. Dissolves easily without residue. For a healthy and successful marine aquarium, we recommend weekly water changes of 5-10%.

**Natural reef salt, with minimal chemical or technical modifications, Colombo Pro Reef Salt simply comes closest to natural seawater.**

**During the evaporation of seawater, bacteria spores remain on the salt, these spores improve biology. Together with the balanced formula and pure ingredients, 95% of Pro Reef salt users see a significant improvement in coral development.**

**Seawater made with Pro Reef contains at a salinity of 25ppt, specific gravity 1024-1026 with the following values: KH:9, Calcium:420, Magnesium:1370, Potassium:400, Strontium:10mg/l.**

### COLOMBO PRO REEF SALT 4 KG STAND PACK.

S.R.P.

**€20,49**

Art. No.: N5060585



8 715897 259364

### COLOMBO PRO REEF SALT 22 KG BUCKET.

S.R.P.

**€85,49**

Art. No.: N5060575



8 715897 259340

### COLOMBO PRO REEF SALT 22 KG BAG.

S.R.P.

**€79,99**

Art. No.: N5060590



8 715897 272578



INDEX

## Marine Sand.

Colombo marine sand is completely natural, making it the ideal substrate for marine and coral aquariums as well as freshwater aquariums with African cichlids.

**A perfect medium for maximum biological activity, available as XS, S and M pellets**

**Before use, rinse out the sand with tap water.**

### COLOMBO MARINE SAND XS 5 KG.

S.R.P.

**€14,99**

Art. No.: N5060293



8 715897 276026

### COLOMBO MARINE SAND S 5 KG.

S.R.P.

**€14,99**

Art. No.: N5060295



8 715897 203879

### COLOMBO MARINE SAND M 5 KG.

S.R.P.

**€14,99**

Art. No.: N5060297



8 715897 276033

# Maintenance



## Silicate Ex.

Special filter material for silicate removal.



Scan for QR code for info.



Excessive levels of silicate, or silica, are the main reason for the presence of diatoms (brown algae). By using Silicate Ex to remove the silicate, the algae can no longer grow and disappear.

Contents 500 ml, use 100 ml per 200 litres of water.

Contents 1000 ml, use 100 ml per 200 litres of water.

**COLOMBO MARINE SILICATE EX 500 ML.**

S.R.P.  
**€22,99**

Art. No.: N5060655



8 715897 304996

**COLOMBO MARINE SILICATE EX 1000 ML.**

S.R.P.  
**€38,29**

Art. No.: N5060660



8 715897 305009

## Pump Clean.

Powerful cleanser/descaler for (flow) pumps and other devices. Regular cleaning of your pumps is necessary for efficient operation, longer life, and retention of warranty.

Immerse devices in the cleaning solution and leave for several hours. Rinse with tap water before returning to aquarium.

Ensures maintenance of capacity and reliability.

Contents: 1000 ml. Sufficient for 10 litres of cleaning solution.

**COLOMBO MARINE PUMP CLEAN 1000 ML.**

S.R.P.  
**€12,99**

Art. No.: N5060680



8 715897 341601

New

# Fish care & Pest control.

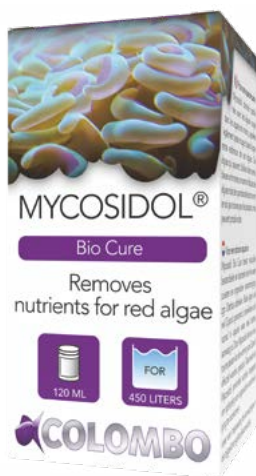

## Mycosidol®.

**For a clean marine aquarium**  
Product for a clean marine aquarium without cyano algae.

Mycosidol Bio Cure contains natural ingredients and bacteria that purify the water and break down organic contaminants called detritus. Red algae also known as Cyanos develop mainly in aquariums where a lot of detritus is present.

Applying Mycosidol as a cure can effectively stop Cyanos formation. In addition, Mycosidol can be applied periodically to prevent accumulation of organic pollutants.

120 ml sufficient to treat 450 litres of water.

**COLOMBO MARINE MYCOSIDOL 120 ML / 450 LTR.**

S.R.P.  
**€20,49**

Art. No.: N5060500



8 715897 259197



## Aiptasidol®.

Aiptasidol is a specially developed liquid that easily removes unwanted Aiptasia.

Aiptasia (glass anemones) can develop explosively and thus become a pest.

Target treatment, so no negative effects on water quality.

One pack can be used for 500 treatments.

**COLOMBO MARINE AIPTASIDOL 100 ML / 500 TREATMENTS.**

S.R.P.  
**€13,79**

Art. No.: N5060505



8 715897 259203



## Cobrasal®.

Niet rif veilige medicatie tegen huid parasieten bij zeewatervissen zoals: Ichthyophthirius, Oodinium, Cryptocaryon.

Zeer effectieve behandeling voor vissen die buiten het rifaquarium kunnen worden behandeld.

Deze krachtige medicatie bevat o.a. Kopersulfaat en is daarom niet veilig voor gebruik in een aquarium met koralen en/of andere lagere dieren.

Inhoud 500ml, voldoende voor de behandeling van 2500 liter water.

**COLOMBO MARINE COBRASAL 500ML 2.500LTR\*.**

S.R.P.  
**€21,99**

Art. no.: N5060620



8 715897 273612

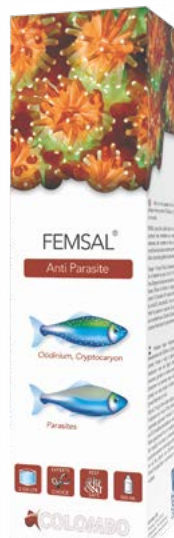

## Femsal®.

Rif veilige medicatie werkzaam tegen huidparasieten bij zeewatervissen zoals Oödinium, Cryptocaryon en anderen.

Symptomen van besmette vissen variëren per parasiet, van witte puntjes of vlekken tot een grauwe fletse kleur en huid.

Deze behandeling is veilig voor het rif bij juist gebruik en kan dus worden toegepast in een gemengd aquarium met lagere dieren

Inhoud 500ml, voldoende voor de behandeling van 2500 liter water.

Inhoud 2.500ml, voldoende voor de behandeling van 12.500 liter water.

**COLOMBO MARINE FEMSAL 500 ML 2.500 LTR\*.**

S.R.P.  
**€22,99**

Art. no.: N5060615



8 715897 273605

**COLOMBO MARINE FEMSAL 2500 ML 12.500 LTR\*.**

S.R.P.  
**€73,49**

Art. no.: N5060617



8 715897 336232

